

FLUOLITE

COMPETENCE IN
LIGHT & LUMINAIRES

LUMINAIRES
CATALOGUE

25

26



Sustainable products from Fluolite
www.fluolite.de/nachhaltigkeit

FLUOLITE

COMPETENCE IN
LIGHT & LUMINAIRES

— SINCE 1926 —

QUALITY FROM
TETTANG

 **MADE IN
GERMANY**

German and European production in compliance with ISO 9001 and ISO 14001.

Strict quality standards for materials, workmanship, technology and service.

Use of green electricity.

Efficient delivery and procurement channels help to reduce our carbon footprint.

Sustainable products thanks to interchangeable components.

LED modules with a long lifetime.

In-house recycling: waste materials are returned to the production cycle.

Fluolite Light & Luminaires Luminaire production in Germany

Our vast experience in the industrial production of plastic parts dates back to 1926.

We have been manufacturing our “Made in Germany” luminaires in the Lake Constance region since the 1950s.

We promise you, our customers, consistently high product quality. For this reason, we predominantly manufacture and assemble our products in our factories in Tettang and elsewhere in the European Union – in compliance with ISO 9001 and ISO 14001. This ensures short delivery and procurement channels. Our satisfied customers are the ultimate proof of our high quality standards.

Efficient use of resources – with respect for the environment

Today, it is becoming increasingly important that companies prioritise environmental protection and carefully consider the consequences of their actions. One way we can actively promote both aspects is by manufacturing sustainable products.

The production of FLUOLITE luminaires includes a strong focus on the environment. We use green electricity and ensure that our LED modules have a long lifetime and are replaceable – these aspects are fundamentally important to us. By returning our production waste to the manufacturing cycle, we reduce both our industrial waste volumes and our demand for raw materials.

Interior lighting

PRODUCT OVERVIEW

Luminaires with a higher protection grade



PAC-D EL ML 13 PAC-D EL 14 PAC-D EL Q 15



PAC-D HP 16 LZP 17 ALSF ML 18



Euro-Line Aqua ML 19

Luminaires for special applications



PAC-D AI 22 - 23 LZP HT 24 - 25

Surface-mounted luminaires



AOT ML 30 AOT Mini ML 31 Euro-Line ML 32



Euro-Line Mini ML 33 DeSpl 34 Quadra-P 35



LUX ML | LUX 36 - 37 LUX ASYM 39

NEW

FLUO

LED LUMINAIRES NEW GENERATION

Pages:

- 18 | ALSF ML
- 19 | Euro-Line Aqua ML
- 30 - 31 | AOT ML & AOT Mini ML
- 32 - 33 | Euro-Line ML & Euro-Line Mini ML
- 42 - 45 | Weiler FL & Weiler-Z FL
- 48 - 55 | RKL ML & RKL-Z ML
- 93 | HiLu ML

MULTILUMEN AND MULTICOLOR TECHNOLOGY

**LONG-LASTING &
ENERGY EFFICIENT**
LUMINOUS EFFICACY OVER 120 Lm/W



MADE IN GERMANY
SUSTAINABLE THANKS TO INTER-
CHANGEABLE COMPONENTS



LITE

Light is our passion!

Our primary goal is to offer you the optimal lighting solution for every application. Perfectly adapted – even to harsh environmental conditions.



Regional production, tailored to your needs

We promise you, our customers, consistently high product quality and the latest technologies. For this reason, we predominantly manufacture and assemble our products in our factories in Tettang and elsewhere in the EU.

NEW

Page 42 – 45

Weiler FL & Weiler-Z FL
two stylish all-rounders

Page 46 – 47

Stylish shades
for Weiler FL luminaires

Wall and ceiling luminaires



Multilumen & Multicolor
Weiler FL | Weiler-Z FL 42 – 45



Multilumen
RKL ML 50 – 52



Multilumen
RKL-Z ML 53 – 55



RKL-Aqua 56 – 57



Quadro-Lite 60



Rondo-Lite 61

Lay-in luminaires | Panel luminaires



UGR < 16
Modul Four EL 64



UGR < 16
Modul Four 65



Multilumen
UGR < 19
Flat-A ML 66 – 67



UGR < 19
FLAT-A 68



UGR < 19
FLAT-E 69

Downlights



ARO 72



UGR < 19
Bodman FL 73

Interior lighting

PRODUCT OVERVIEW

Trunking systems and battens



TRX 76 - 78



TRX Lens 79



TRA 80 - 85



TRA click & connect 86 - 87



Minilite 89

High-bay luminaires



PAC-D MaXX | PAC-D MaXX Focus 92



HiLu ML 93

Ball-proof luminaires



InAct 96

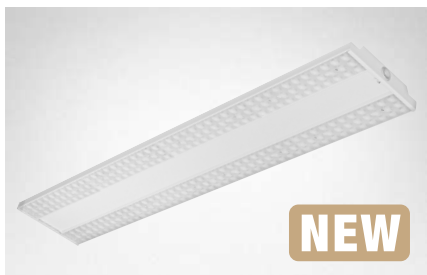

Salem FL 97

Multilumen LED panel

Page 66 - 67 | **Multilumen technology for office installations**
FLAT-A ML

The perfect solution for new installations and refurbishment projects.



NEW

Ball-proof luminaire

Page 97 | **Ball-proof, compact and robust luminaire with lens optics**
Salem FL



Exterior lighting

PRODUCT OVERVIEW

Covered outdoor areas



PAC-D EL ML 13



PAC-D EL 14



PAC-D EL Q 15



PAC-D HP 16



LZP 17



ALSF ML 18



Euro-Line Aqua ML 19



PAC-D AI 22 - 23



RKL-Aqua 56 - 57



Quadro-Lite 60



Rondo-Lite 61



PAC-D MaXX | PAC-D MaXX Focus 92

Uncovered outdoor areas



LZP HT 24 - 25

Luminaires for VDU workstations

Pages:

- 35 | Quadra-P
- 36 - 39 | LUX, LUX ML, LUX ASYM
- 64 - 65 | Modul Four EL, Modul Four
- 66 - 67 | FLAT-A ML
- 68 - 69 | FLAT-A, FLAT-E
- 73 | Bodman FL



High-bay luminaires



Page 92

For high ceilings with optimised light distribution
PAC-D MaXX | Focus

Luminaires for LEDtube

PRODUCT OVERVIEW

Luminaires with a higher protection grade



PAC-D

99



PACN | PACE

99



LZP

100



Euro-FFL

100



ALSF

101



Euro-Line Aqua

101

Surface-mounted luminaires



AOT

102



Euro-Line

102



LUX

103

Trunking systems and battens



TRX

104



SFN / SFX

104

Retrofit luminaires

PRODUCT OVERVIEW

Wall and ceiling luminaires



RKL

105



RKL-Aqua

105

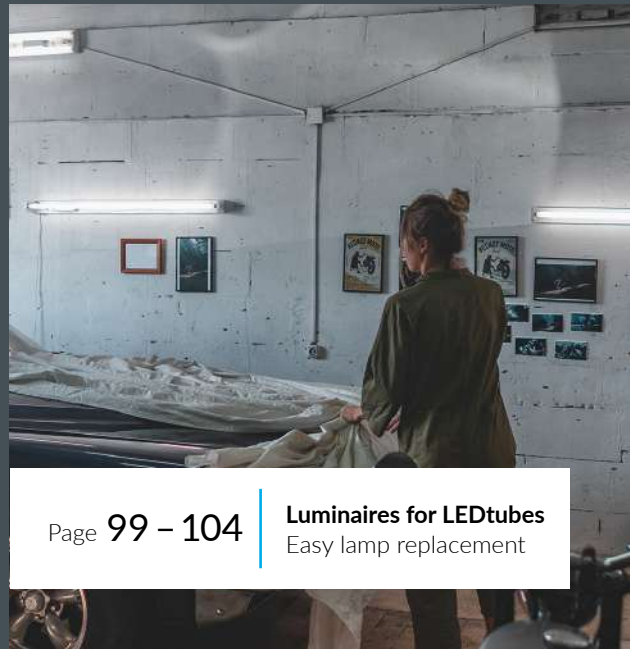

Page 99 – 104

Luminaires for LEDtubes
Easy lamp replacement



Service & upgrades

Page 116 – 119

Competent lighting solutions, sustainable upgrades and top service



NEW: Multilumen function

Page **50 – 55** | **RKL & RKL-Z ML**
Unobtrusive design
with numerous variants



Page **105**

Retrofit
LED technology
for RKL E27 types

At a glance!

Our overview pages –
Easily compare
our products

- ⊙ User-friendly
- ⊙ Clearly arranged
- ⊙ Compact
- ⊙ Effective

Page **26 – 27** | PAC-D & LZP
Page **58 – 59** | RKL, RKL-Z & RKL-Aqua

Safety lighting

PRODUCT OVERVIEW

Rescue and safety luminaires



FLS 1 Display
Autotest 107



FL 2 Autotest 108



FL 4 Autotest 108



FL 3 Display-E
Autotest 109



FL 3 Display-R
Autotest 109

Replacement parts

PRODUCT OVERVIEW

Replacement diffusers for moisture-proof luminaires with diffusers	110
Replacement diffusers for wall and ceiling luminaires	111 – 112
Replacement gear trays for moisture-proof luminaires with diffusers	112
Closures	113
Installation components / Wire mesh protection	113
Replacement diffusers and luminaire housings for ALSF AOT Euro-Line	114 – 115

Service & upgrades

The Fluolite service concept	116
Sustainable upgrades	117
Fluolite after-sales service	118
Subsidised Fluolite luminaire families	119

Technical annex

PAC-D & LZP luminaires at a glance	26 – 27
All RKL luminaires at a glance	58 – 59
Chemical resistance	120
Technical information – HF sensor	121
Protection grades / Protection classes / Certification marks / Impact resistance	122 – 123
Sustainable products from Fluolite	124 – 125
Warranty for LED luminaires	128
General Terms and Conditions	130 – 131





Luminaires with a higher protection grade

- | | | |
|--|--|--|
| 
PAC-D EL ML 13 | 
PAC-D EL 14 | 
PAC-D EL Q 15 |
| 
PAC-D HP 16 | 
LZP 17 | 
ALSF ML 18 |
| 
Euro-Line Aqua ML 19 | | |

Moisture-proof luminaires are specially designed for use in humid, wet and/or dusty environments. Our product families include a large variety of types and are the ideal solution for a wide range of applications.

PAC-D luminaire family

Highlights

Technical variants



Multilumen
Adjustable light output



DALI
With dimming function



HF sensor
Master / Slave



3h emergency lighting
With emergency lighting function

Sustainability across the board



Eligible for funding
The perfect solution for new installations and refurbishment projects.



Made in Germany
German and European production in accordance with ISO 9001 and ISO 14001.



Sustainable
thanks to energy-efficient LED technology and replaceable components.



5-year Fluolite warranty
for luminaires with a lifetime of $\geq 50,000$ operating hours.

Shock resistance



Acrylic (PMMA)

- Very good UV resistance
- Resistant to greases, oils, acids and alkaline cleaners



Polycarbonate (PC)

- Excellent shock resistance
- High rigidity

Installation options

Wall Ceiling Trunking Suspended



Beam type

Extensive



Lengths



approx. 660 / 1220 / 1520 mm

Accessories / Installation components

Replacement diffusers, replacement appliance supports, closures, installation components, wire mesh protection (page 110+)



PAC-D EL ML

LED MOISTURE-PROOF LUMINAIRE WITH DIFFUSER

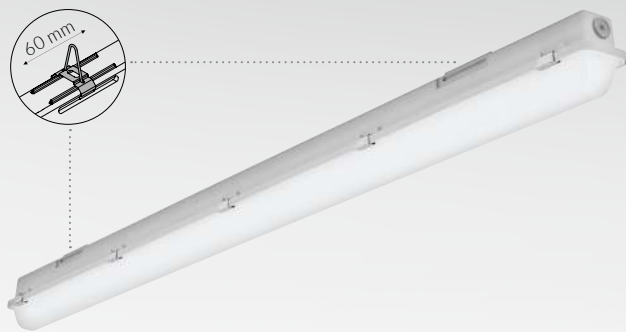

POWERFUL technology

PREMIUM quality

UNBEATABLE PRICE

Luminaire housing made of glass-fibre-reinforced polyester, light grey, flame retardant. Diffuser made of UV-resistant PMMA (IK 03) or PC (IK 07). High-quality closures and multifunctional mounting brackets made from stainless steel (V2A) for rapid installation. Suitable for ceiling or wall mounting indoors and in covered outdoor areas.

- ☛ Multilumen function
- ☛ ENEC and VDE certification marks
- ☛ Sustainable product thanks to replaceable LED module
- ☛ Luminous efficacy up to 168 Lm/W (eligible for funding)
- ☛ Safe for use in the food industry – HACCP-certified
- ☛ AC/DC capable
- ☛ Long LED lifetime – 50,000 h for L80/B10
- ☛ High-quality materials and components
- ☛ Colour tolerance (initial MacAdam) 3
- ☛ Suitable for surface-mounting, trunking or suspended mounting
- ☛ Versions with 6,500 Kelvin optionally available
- ☛ Plastic closures optionally available
- ☛ - symbol, suitable for rooms with an elevated fire risk

PAC-D EL with Multilumen function

Diffuser made of UV-resistant acrylic (PMMA), IK 03

Type	Version	Colour temp. (K)	Luminous flux (Lm)	System power (W)	LED lifetime	L	E1	E2 (± 60 mm)	PU	Article No.	Gross €/pcs.
PAC-D EL ML opal	650 Basic	4000	2300 / 1500	17 / 10	50,000 h	L80/B10	660	510	360	240	6324 1050 • 61.30
	1200 Basic	4000	4400 / 2700	31 / 18	50,000 h	L80/B10	1220	880	760	120	6324 1350 • 75.30
	TW 5 x 2.5	4000	4400 / 2700	31 / 18	50,000 h	L80/B10	1220	880	760	120	6324 1367 • 85.00
	1500 Basic	4000	5900 / 3700	43 / 25	50,000 h	L80/B10	1520	1180	1060	120	6324 1550 • 82.30
	TW 5 x 2.5	4000	5900 / 3700	43 / 25	50,000 h	L80/B10	1520	1180	1060	120	6324 1567 • 96.00
	HF sensor	4000	5900 / 3700	43 / 25	50,000 h	L80/B10	1520	1180	1060	120	6324 1551 • 148.80
PAC-D EL ML pearled	1200 Basic	4000	4700 / 2900	31 / 18	50,000 h	L80/B10	1220	880	760	120	6324 1850 • 79.80
	TW 5 x 2.5	4000	4700 / 2900	31 / 18	50,000 h	L80/B10	1220	880	760	120	6324 1875 • 89.80
	1500 Basic	4000	6400 / 4000	43 / 25	50,000 h	L80/B10	1520	1180	1060	120	6324 2050 • 87.30
	TW 5 x 2.5	4000	6400 / 4000	43 / 25	50,000 h	L80/B10	1520	1180	1060	120	6324 2075 • 99.80

Shock-resistant polycarbonate (PC) diffuser, IK 07

PAC-D/PC EL ML opal	650 Basic	4000	2300 / 1500	17 / 10	50,000 h	L80/B10	660	510	360	240	6324 1080 • 66.30
	1200 Basic	4000	4400 / 2700	31 / 18	50,000 h	L80/B10	1220	880	760	120	6324 1355 • 78.00
	TW 5 x 2.5	4000	4400 / 2700	31 / 18	50,000 h	L80/B10	1220	880	760	120	6324 1310 • 91.30
	1500 Basic	4000	5900 / 3700	43 / 25	50,000 h	L80/B10	1520	1180	1060	120	6324 1555 • 86.80
	TW 5 x 2.5	4000	5900 / 3700	43 / 25	50,000 h	L80/B10	1520	1180	1060	120	6324 1560 • 102.00
	HF sensor	4000	5900 / 3700	43 / 25	50,000 h	L80/B10	1520	1180	1060	120	6324 1556 • 156.30

• available ex stock | For suitable replacement diffusers and accessories see page 110+

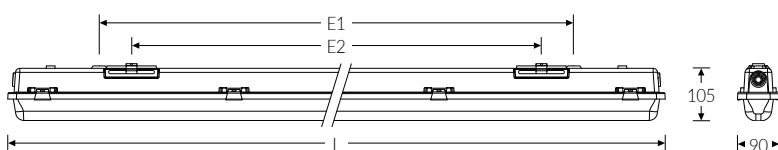

PAC-D EL ML online:
www.fluolite.de/produkte/serie/pac-d-el-ml

PAC-D EL

LED MOISTURE-PROOF LUMINAIRE WITH DIFFUSER



PAC-D EL with DALI dimmable and emergency lighting function

Type	Version	Colour temp. (K)	Luminous flux (Lm)	System power (W)	LED lifetime	L	E1	E2 (± 60 mm)	PU	Article No.	Gross €/pcs.		
PAC-D EL opal	1200	DALI + TW 5 x 2.5	4000	4400	31	50,000 h	L80/B10	1220	880	760	120	6324 1375	111.00
		EL 3 h Autotest	4000	4400	31	50,000 h	L80/B10	1220	880	760	120	6324 1380	330.00
	1500	DALI + TW 5 x 2.5	4000	5900	43	50,000 h	L80/B10	1520	1180	1060	120	6324 1575•	119.50
		EL 3 h Autotest	4000	5900	45	50,000 h	L80/B10	1520	1180	1060	120	6324 1580•	336.30

• available ex stock | For suitable replacement diffusers and accessories see page 110+

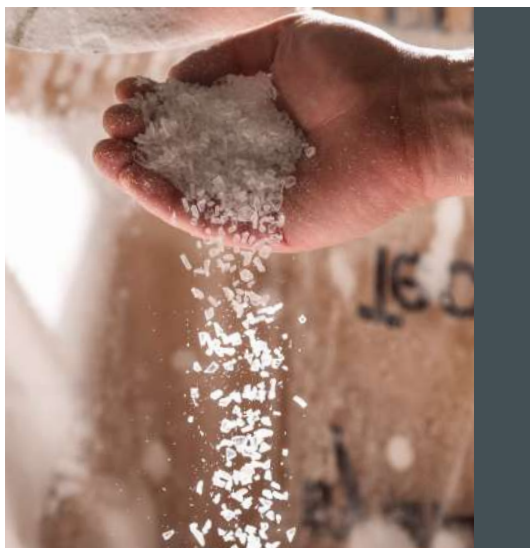
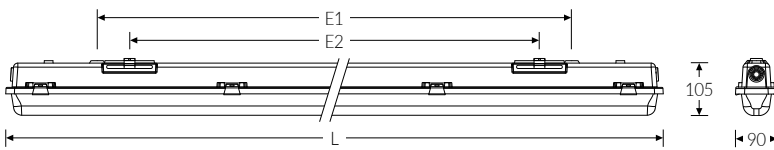

The differences between acrylic (PMMA), IK 03 and polycarbonate (PC), IK 07

Acrylic (PMMA) offers the following advantages:

- ☞ High resistance to weathering
- ☞ Very good UV resistance
- ☞ Excellent chemical resistance
- ☞ Resistant to greases, oils, acids and alkaline cleaners

Polycarbonate (PC) offers the following advantages:

- ☞ Excellent shock resistance
- ☞ Considerable breaking strength
- ☞ High thermal stability
- ☞ High rigidity



PAC-D EL Q

LED MOISTURE-PROOF LUMINAIRE WITH DIFFUSER

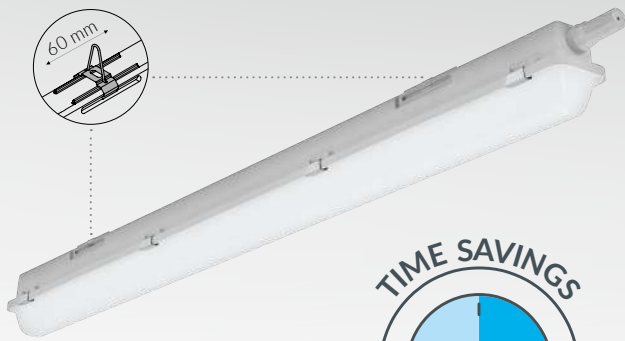

during electrical installation

Q – Quick-Mounting System

The PAC-D EcoLine Q is the ideal solution for easy and time-saving installation.

- ✔ **ENEC and VDE certification marks**
- ✔ **Sustainable product thanks to replaceable LED module**
- ✔ **Luminous efficacy up to 150 Lm/W (eligible for funding)**
- ✔ **Safe for use in the food industry – HACCP-certified**
- ✔ **AC/DC capable**
- ✔ Long LED lifetime – 50,000 h for L80/B10
- ✔ Colour tolerance (initial MacAdam) 3
- ✔ Suitable for surface-mounting, trunking or suspended mounting

Type	Version	Colour temp. (K)	Luminous flux (Lm)	System power (W)	LED lifetime	L1	L2	E1	E2 (± 60 mm)	PU	Article No.	Gross €/pcs.		
PAC-D EL Q	1200	Basic	4000	2700	18	50,000 h	L80/B10	1220	1280	880	760	120	6324 6105	83.50
			4000	4400	31	50,000 h	L80/B10	1220	1280	880	760	120	6324 6125	83.50
	TW 3 x 2.5	4000	2700	18	50,000 h	L80/B10	1220	1340	880	760	120	6324 6115	97.30	
		4000	4400	31	50,000 h	L80/B10	1220	1340	880	760	120	6324 6135	97.30	
	1500	Basic	4000	3700	25	50,000 h	L80/B10	1520	1580	1180	1060	120	6324 6605	91.30
			4000	5900	43	50,000 h	L80/B10	1520	1580	1180	1060	120	6324 6625 •	91.30
4000			9000	60	50,000 h	L80/B10	1520	1580	1180	1060	120	6324 6645 •	155.00	
TW 3 x 2.5		4000	3700	25	50,000 h	L80/B10	1520	1640	1180	1060	120	6324 6615	102.50	
		4000	5900	43	50,000 h	L80/B10	1520	1640	1180	1060	120	6324 6635 •	102.50	
		4000	9000	60	50,000 h	L80/B10	1520	1640	1180	1060	120	6324 6655 •	197.50	

• available ex stock | For suitable replacement diffusers and accessories see page 110+

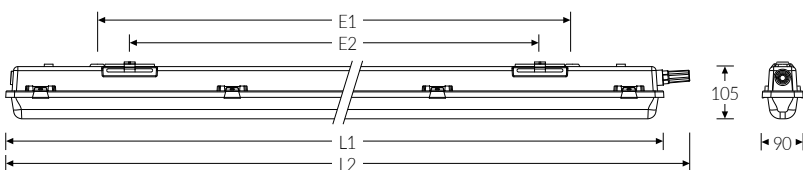

CLICK – Simply click the lamp into the previously installed mounting brackets.



CONNECT – The electrical connection is established from the outside using the plug-in contact system, there is no need to reach inside the luminaire.



FINISHED – Screw the protective plug in place over the connection to ensure that the higher IP 65 protection grade is maintained.



PAC-D EL Q online:
www.fluolite.de/produkte/serie/pac-d-el-q

PAC-D HP

LED MOISTURE-PROOF LUMINAIRE WITH DIFFUSER



Up to 12,600 lumens

Versions with 6500 Kelvin available

Available with a very high colour rendering index of CRI 90

For a powerful and appealing radiance.

Luminaire housing made of glass-fibre-reinforced polyester, light grey, flame retardant. Diffuser made of UV-resistant PMMA. High-quality closures and multifunctional mounting brackets made from stainless steel (V2A) for rapid installation. Suitable for ceiling or wall mounting indoors and in covered outdoor areas.

- ⚡ Long LED lifetime – up to 72,000 h for L80/B10
 - ⚡ Luminous efficacy up to 158 Lm/W (eligible for funding)
 - ⚡ Sustainable product thanks to replaceable LED module
 - ⚡ Safe for use in the food industry – HACCP-certified
 - ⚡ AC/DC capable
- Homogeneous illumination
 - Colour tolerance (initial MacAdam) 3
 - Suitable for surface-mounting, trunking or suspended mounting
 - Plastic closures optionally available
 - - symbol, suitable for rooms with an elevated fire risk

Type	Version	Colour temp. (K)	Luminous flux (Lm)	System power (W)	LED lifetime	L	E1	E2 (± 60 mm)	PU	Article No.	Gross €/pcs.
PAC-D HP	1500 Basic	4000	9000	60	50,000 h L80/B10	1520	1180	1060	120	6323 8260 •	149.50
		4000	12,600	80	50,000 h L80/B10	1520	1180	1060	120	6323 8250 •	217.00
		6500	9000	60	50,000 h L80/B10	1520	1180	1060	120	6323 8270 •	176.00
	TW 5 x 2.5	4000	9000	60	50,000 h L80/B10	1520	1180	1060	120	6323 8265	192.40
		4000	12,600	80	50,000 h L80/B10	1520	1180	1060	120	6323 8255	223.00
		6500	9000	60	50,000 h L80/B10	1520	1180	1060	120	6323 8275 •	187.50

NEW

Now with CRI 90! Very high colour rendering index: $R_a \geq 90$

Ideal for use in accordance with DIN EN 12464-1 in industrial workplaces and craft workshops, e.g. woodworking companies, print and paint shops, as well as healthcare facilities and changing/fitting rooms.

Type	Version	Colour temp. (K)	Luminous flux (Lm)	System power (W)	LED lifetime	L	E1	E2 (± 60 mm)	PU	Article No.	Gross €/pcs.
PAC-D HP CRI90 opal	1500 Basic	4000	9600	76	72,000 h L80/B10	1520	1180	1060	120	6323 8330	180.00
	TW 5 x 2.5	4000	9600	76	72,000 h L80/B10	1520	1180	1060	120	6323 8320	195.00
PAC-D HP CRI90 pearled	1500 Basic	4000	10,300	76	72,000 h L80/B10	1520	1180	1060	120	6323 8310	180.00
	TW 5 x 2.5	4000	10,300	76	72,000 h L80/B10	1520	1180	1060	120	6323 8300	195.00

• available ex stock | For suitable replacement diffusers and accessories see page 110+

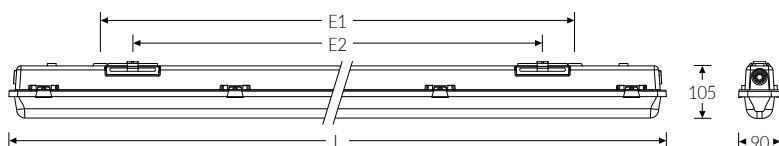

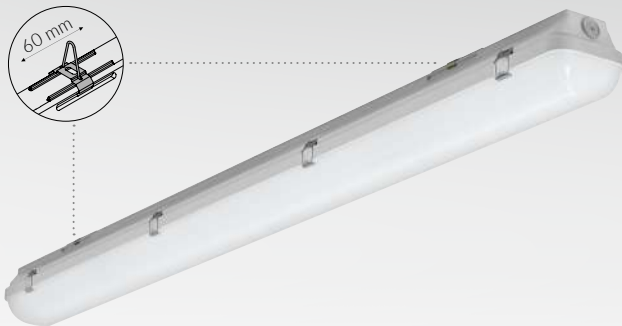

One series with numerous variants.

Luminaire housing made of glass-fibre-reinforced polyester, light grey, flame retardant. Non-ageing, foamed PU seal. LED optical system mounted on white gear tray. Opal PC diffuser, impact resistant and UV-stabilised with internal longitudinal prisms. Multifunctional stainless-steel mounting brackets for rapid installation (luminaire can be clipped in). Suitable for ceiling or wall mounting. Approved for use indoors or in covered outdoor areas.

- ☛ High protection grade IP 66, high shock resistance to IK 07
- ☛ Sustainable product thanks to replaceable LED module
- ☛ Luminous efficacy up to 142 Lm/W (eligible for funding)
- ☛ Safe for use in the food industry – HACCP-certified
- ☛ AC/DC capable

- ☛ Uniform light distribution in the room
- ☛ Long LED lifetime – 50,000 h for L80/B10
- ☛ Colour tolerance (initial MacAdam) 3
- ☛ Ambient temperature from –20°C to +35°C
- ☛ Versions with HF sensor, DALI and 3-hour emergency lighting available
- ☛ High-quality closures made of stainless steel, captive design
- ☛ ▽ - symbol, suitable for rooms with an elevated fire risk

Type	Version	Colour temp. (K)	Luminous flux (Lm)	System power (W)	LED lifetime	L	E1	E2 (± 60 mm)	PU	Article No.	Gross €/pcs.		
LZP	1250	Basic	4000	3800	33	50,000 h	L80/B10	1270	840	865	100	61072010	118.50
			4000	6000	44	50,000 h	L80/B10	1270	840	865	100	61072510	139.50
	Basic TW 5 x 2.5	4000	3800	33	50,000 h	L80/B10	1270	840	865	100	61072020	131.00	
		4000	6000	44	50,000 h	L80/B10	1270	840	865	100	61072520	167.00	
	HF sensor (Master/Slave) + TW 5 x 1.5	4000	3800	33	50,000 h	L80/B10	1270	840	865	100	61072055	138.10	
		4000	6000	44	50,000 h	L80/B10	1270	840	865	100	61072555	172.20	
	DALI + TW 5 x 1.5	4000	4100	33	50,000 h	L80/B10	1270	840	865	100	61072035	173.50	
		4000	6000	44	50,000 h	L80/B10	1270	840	865	100	61072535	176.80	
	3h emergency lighting	4000	4100	36	50,000 h	L80/B10	1270	840	865	100	61072070	352.40	
		4000	6000	47	50,000 h	L80/B10	1270	840	865	100	61072570	376.00	
	1550	Basic	4000	4200	35	50,000 h	L80/B10	1570	1140	1165	100	61073010 •	132.80
			4000	6800	53	50,000 h	L80/B10	1570	1140	1165	100	61073510	162.80
		Basic TW 5 x 2.5	4000	4200	35	50,000 h	L80/B10	1570	1140	1165	100	61073020	150.80
			4000	6800	53	50,000 h	L80/B10	1570	1140	1165	100	61073520	192.70
HF sensor (Master/Slave) + TW 5 x 1.5		4000	4200	35	50,000 h	L80/B10	1570	1140	1165	100	61073055 •	161.20	
		4000	6800	53	50,000 h	L80/B10	1570	1140	1165	100	61073555	202.00	
DALI + TW 5 x 1.5		4000	4600	35	50,000 h	L80/B10	1570	1140	1165	100	61073035	184.40	
		4000	7500	53	50,000 h	L80/B10	1570	1140	1165	100	61073535	211.40	
3h emergency lighting		4000	4600	39	50,000 h	L80/B10	1570	1140	1165	100	61073070	346.90	
		4000	7500	56	50,000 h	L80/B10	1570	1140	1165	100	61073570	364.20	

• available ex stock | For suitable replacement diffusers and accessories see page 110+

Installation options:

Walls, ceiling, trunking, suspended mounting.

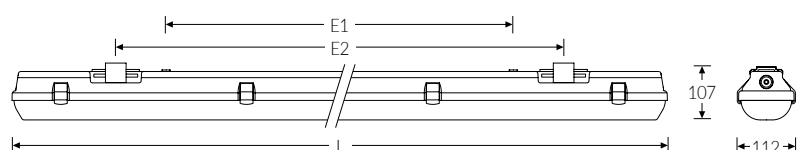

LZP online:
www.fluolite.de/produkte/serie/lzp

ALSF ML

LED MOISTURE-PROOF SURFACE-MOUNTED LUMINAIRE



NEW: Multilumen function

Luminaire housing made of white, glass-fibre-reinforced polyester, flame retardant. Opal acrylic diffuser (PMMA), smooth exterior, angular design. High-quality, circumferentially foamed, water-repellent seal made of polyurethane to ensure a higher protection grade. Internal closure device. Rear wiring channel for through-wiring. Suitable for ceiling or wall mounting. Approved for use indoors or in covered outdoor areas.

- ☑ **New: Multilumen function**
- ☑ **Classic design with clean lines**
- ☑ **Sustainable product thanks to replaceable LED module**
- ☑ **AC/DC capable**

- ☑ Long LED lifetime – 50,000 h for L80/B10
- ☑ Colour tolerance (initial MacAdam) 3
- ☑ Non-ageing PU seal
- ☑ Halogen-free wiring
- ☑ Versions with HF sensor, DALI and 3-hour emergency lighting available
- ☑ For use in harsh environments

ALSF with Multilumen function

Type	Version	Colour temp. (K)	Luminous flux (Lm)	System power (W)	LED lifetime	L	H	E	PU	Article No.	Gross €/pcs.		
ALSF ML	650	Basic	3000	2900 / 1800	27 / 16	50,000 h	L80/B10	650	87	460	160	6011 1110	100.00
			4000	3000 / 1900	27 / 16	50,000 h	L80/B10	650	87	460	160	6011 1120	100.00
	1260	Basic	3000	4700 / 2900	42 / 27	50,000 h	L80/B10	1260	95	740	80	6011 1200	160.00
			4000	5000 / 3200	42 / 27	50,000 h	L80/B10	1260	95	740	80	6011 1210	160.00
		HF sensor (Master/Slave)	3000	4700 / 2900	42 / 27	50,000 h	L80/B10	1260	95	740	80	6011 1220	241.10
			4000	5000 / 3200	42 / 27	50,000 h	L80/B10	1260	95	740	80	6011 1230	241.10
		3h emergency lighting	3000	4700 / 2900	42 / 27	50,000 h	L80/B10	1260	95	740	80	6011 1240	350.00
			4000	5000 / 3200	42 / 27	50,000 h	L80/B10	1260	95	740	80	6011 1250	350.00
	1560	Basic	3000	6300 / 4800	55 / 43	50,000 h	L80/B10	1560	95	850	80	6011 1600	170.00
			4000	6600 / 5100	55 / 43	50,000 h	L80/B10	1560	95	850	80	6011 1610	170.00
		HF sensor (Master/Slave)	3000	6300 / 4800	55 / 43	50,000 h	L80/B10	1560	95	850	80	6011 1620	285.00
			4000	6600 / 5100	55 / 43	50,000 h	L80/B10	1560	95	850	80	6011 1630	285.00
3h emergency lighting		3000	6300 / 4800	55 / 43	50,000 h	L80/B10	1560	95	850	80	6011 1640	369.00	
		4000	6600 / 5100	55 / 43	50,000 h	L80/B10	1560	95	850	80	6011 1650	369.00	

ALSF with DALI dimmable

Type	Version	Colour temp. (K)	Luminous flux (Lm)	System power (W)	LED lifetime	L	H	E	PU	Article No.	Gross €/pcs.		
ALSF	1260	DALI	3000	4700	42	50,000 h	L80/B10	1260	95	740	80	6011 1280	212.00
			4000	5000	42	50,000 h	L80/B10	1260	95	740	80	6011 1285	212.00
	1560	DALI	3000	6300	55	50,000 h	L80/B10	1560	95	850	80	6011 1660	214.00
			4000	6600	55	50,000 h	L80/B10	1560	95	850	80	6011 1670	214.00

For suitable replacement diffusers and luminaire housings see page 114+

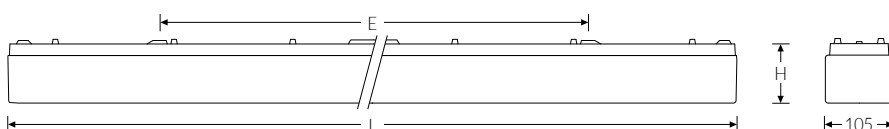

Euro-Line Aqua ML





LED MOISTURE-PROOF SURFACE-MOUNTED LUMINAIRE







CE \oplus ∇ IK02 IP54



NEW: Multilumen function

Luminaire housing made of white, glass-fibre-reinforced polyester, flame retardant. Opal acrylic diffuser (PMMA), smooth exterior, bevelled edges. High-quality, circumferentially foamed, water-repellent seal made of polyurethane to ensure a higher protection grade. Internal closure device. Rear wiring channel for through-wiring. Suitable for ceiling or wall mounting. Approved for use indoors or in covered outdoor areas.

-  **New: Multilumen function**
-  **Bevelled edges for a timeless design**
-  **Sustainable product thanks to replaceable LED module**
-  **AC/DC capable**

-  Long LED lifetime – 50,000 h for L80/B10
-  Colour tolerance (initial MacAdam) 3
-  Non-ageing PU seal
-  Halogen-free wiring
-  Variants with HF sensor available
-  For use in harsh environments

Euro-Line Aqua with Multilumen function

Type	Version	Colour temp. (K)	Luminous flux (Lm)	System power (W)	LED lifetime	L	H	E	PU	Article No.	Gross €/pcs.	
Euro-Line Aqua ML	650 Basic	3000	2900 / 1800	27 / 16	50,000 h L80/B10	660	87	460	160	6011 1130	99.00	
		4000	3000 / 1900	27 / 16	50,000 h L80/B10	660	87	460	160	6011 1140	99.00	
	1270 Basic	3000	4700 / 2900	42 / 27	50,000 h L80/B10	1270	95	740	80	6011 1290	159.00	
			5000 / 3200	42 / 27	50,000 h L80/B10	1270	95	740	80	6011 1295	159.00	
		HF sensor (Master/Slave)	3000	4700 / 2900	42 / 27	50,000 h L80/B10	1270	95	740	80	6011 1300	240.00
			4000	5000 / 3200	42 / 27	50,000 h L80/B10	1270	95	740	80	6011 1310	240.00
	1570 Basic	3000	6300 / 4800	55 / 43	50,000 h L80/B10	1570	95	850	80	6011 1680	170.00	
			4000	6600 / 5100	55 / 43	50,000 h L80/B10	1570	95	850	80	6011 1685	170.00
		HF sensor (Master/Slave)	3000	6300 / 4800	55 / 43	50,000 h L80/B10	1570	95	850	80	6011 1690	285.00
			4000	6600 / 5100	55 / 43	50,000 h L80/B10	1570	95	850	80	6011 1695	285.00

For suitable replacement diffusers and luminaire housings see page 114+

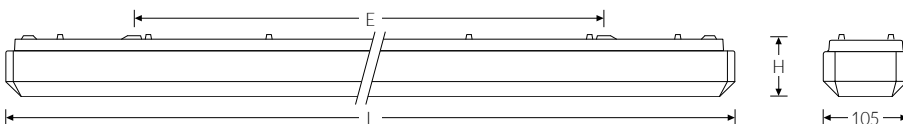





Luminaires for special applications



PAC-D AI 22 - 23



LZP HT 24 - 25

Various requirements with regard to chemical resistance, extreme ambient temperatures and high dust loads – as well as the challenging conditions in agricultural facilities and the food industry – demand the use of high-quality luminaires that are built to withstand punishment.

Agriculture & Industry



One luminaire for extreme conditions.

High-quality luminaire for agriculture and industry – designed for professional use in **damp, wet, dusty environments** and **areas exposed to ammonia**. Energy-efficient, high-quality technology guarantees flicker-free, low-glare and homogeneous illumination.

Thanks to the high IP 69K protection grade, the luminaire is permanently **protected** against the **ingress of dust and jets of water** with a max. temperature of 80°C and a max. jet pressure of 80 bar at a distance of >10 cm.

Certified with the "D" symbol, the PAC-D AI luminaires are approved for use in operating sites that are liable to fire hazards. These include stables, barns, farms, facilities in the wood and paper industry, warehouses and storage rooms.

PAC-D AI

LED MOISTURE-PROOF LUMINAIRE WITH DIFFUSER

CE



Luminaire housing made of glass-fibre-reinforced polyester, light grey, flame retardant. Opal acrylic diffuser (PMMA). High-quality closures made of stainless steel (V2A). Multifunctional stainless-steel mounting brackets for rapid installation (luminaire can be clipped in). Suitable for ceiling or wall mounting. Approved for use indoors or in covered outdoor areas.

☛ Meets all requirements for efficient, high-quality lighting for the promotion of animal welfare

☛ Additional variants with DLG certification optionally available

☛ Sustainable product thanks to replaceable LED module

☛ Luminous efficacy up to 148 Lm/W **(eligible for funding)**

☛ Safe for use in the food industry – HACCP-certified

- ☛ Long LED lifetime – 50,000 h for L80/B10
- ☛ Colour tolerance (initial MacAdam) 3
- ☛ Ambient temperature from -20°C to +35°C
- ☛ Non-ageing PU seal
- ☛ Suitable for surface-mounting, trunking or suspended mounting
- ☛ AC/DC capable
- ☛ - symbol, suitable for rooms with an elevated fire risk

Type	Version	Colour temp. (K)	Luminous flux (Lm)	System power (W)	LED lifetime	L	E1	E2 (± 60 mm)	PU	Article No.	Gross €/pcs.	
PAC-D AI	1200	Basic	4000	4900	35	50,000 h	L80/B10	1220	880	760	120	6325 1000 • 116.50
		TW 5 x 2.5	4000	4900	35	50,000 h	L80/B10	1220	880	760	120	6325 1050 • 127.50
		DALI	4000	4900	35	50,000 h	L80/B10	1220	880	760	120	6325 1200 • 154.00
		DALI + TW 5 x 2.5	4000	4900	35	50,000 h	L80/B10	1220	880	760	120	6325 1250 • 159.00
	1500	Basic	4000	6200	42	50,000 h	L80/B10	1520	1180	1060	120	6325 2000 • 131.00
		TW 5 x 2.5	4000	6200	42	50,000 h	L80/B10	1520	1180	1060	120	6325 2050 • 144.90
		DALI	4000	7100	48	50,000 h	L80/B10	1520	1180	1060	120	6325 2200 • 167.90
		DALI + TW 5 x 2.5	4000	7100	48	50,000 h	L80/B10	1520	1180	1060	120	6325 2250 • 179.90

• available ex stock | For suitable replacement diffusers and accessories see page 110+

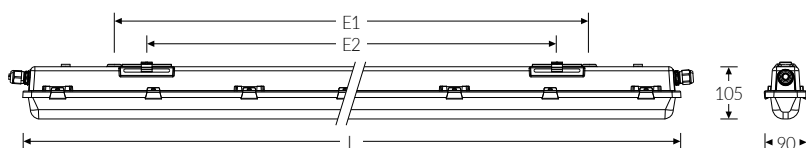

PAC-D AI online:
www.fluolite.de/produkte/serie/pac-d-ai

High and low temperature

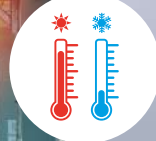

A luminaire designed for extreme temperature ranges.

In the industrial sector, luminaires are largely selected on the basis of their light output. However, their lifetime also plays a particularly important role. This is determined to a large extent by the ambient temperature.

Our LZP HT LED moisture-proof luminaire is a powerful and robust luminaire for demanding requirements, including **temperatures from -40°C to +55°C.**

LZP HT

LED MOISTURE-PROOF LUMINAIRE WITH DIFFUSER

CE ⊕ ⚡ ⚠ IK07 IP66

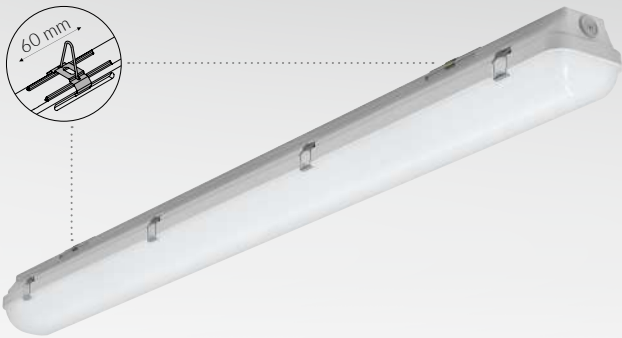

Luminaire housing made of glass-fibre-reinforced polyester, light grey, flame retardant. Opal polycarbonate (PC) diffuser, impact-resistant and UV-stabilised with internal longitudinal prisms. Multifunctional stainless-steel mounting brackets for rapid installation (luminaire can be clipped in).

Suitable for mounting on walls, ceilings, trunking (e.g. TRA) or for suspended mounting in industry, parking areas, workshops, warehouses and assembly halls as well as cold stores, taking into account the temperature ranges.

- ☑ Ambient temperature from **-40°C to +55°C**
- ☑ Sustainable product thanks to replaceable LED module
- ☑ Luminous efficacy up to **132 Lm/W** (eligible for funding)
- ☑ AC/DC capable
- ☑ Safe for use in the food industry – HACCP-certified
- ☑ Suitable for uncovered outdoor areas

- ☑ Long LED lifetime – 50,000 h for L80/B10
- ☑ Colour tolerance (initial MacAdam) 3
- ☑ Non-ageing PU seal
- ☑ High-quality closures made of stainless steel, captive design
- ☑ Approved for use indoors and in protected and unprotected outdoor areas
- ☑ ⚠ - symbol, suitable for rooms with an elevated fire risk

Type	Version	Colour temp. (K)	Luminous flux (Lm)	System power (W)	LED lifetime	L	E1	E2 (± 60 mm)	PU	Article No.	Gross €/pcs.
LZP HT	1250	Basic	4000	4500	34	70,000h L80/B10	1270	840	865	100	6107 2710 • 167.50
	1550	Basic	4000	5500	42	70,000h L80/B10	1570	1140	1165	100	6107 3710 • 187.50

• available ex stock | For suitable replacement diffusers and accessories see page 110+

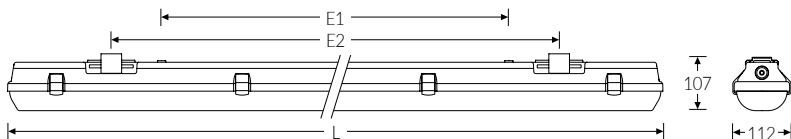

LZP HT online:
www.fluolite.de/produkte/serie/lzp-ht





PAC-D & LZP luminaires at a glance!

The table shows the available PAC-D and LZP luminaire types for a direct comparison of their properties and features.



	PAC-D EL ML PAC-D EL LED moisture-proof luminaire with Multilumen function		PAC-D EL Q LED moisture-proof luminaire with Quick-Mounting System	PAC-D HP High-performance LED moisture-proof luminaire with up to 12,600 lumens
Mounting type	Ceiling or wall mounting		Ceiling or wall mounting	Ceiling or wall mounting
Application area	<ul style="list-style-type: none"> Underground and multi-storey car parks Industrial buildings and warehouses that require a high protection grade Production and storage facilities in the food industry Workshops Warehouses and shipping bays <p>Approved for use indoors or in covered outdoor areas.</p>		<ul style="list-style-type: none"> Underground and multi-storey car parks Industrial buildings and warehouses that require a high protection grade Production and storage facilities in the food industry Workshops Warehouses and shipping bays <p>Approved for use indoors or in covered outdoor areas.</p>	<ul style="list-style-type: none"> Underground and multi-storey car parks Industrial buildings and warehouses that require a high protection grade Production and storage facilities in the food industry Workshops Warehouses and shipping bays <p>Approved for use indoors or in covered outdoor areas.</p>
Multilumen function	✓	-	-	-
Eligible for funding	✓	✓	✓	✓
HF sensor (Master/Slave capable)	✓	available on request	available on request	available on request
DALI (dimnable)	-	✓	available on request	✓
AC/DC capable	✓	✓	✓	✓
Emergency lighting function	-	✓	available on request	available on request
Constant luminous flux control (CLO – Constant Light Output)	-	-	-	available on request
Colour rendering index (CRI) Ra > 80	✓	✓	✓	✓
Colour rendering index (CRI) Ra > 90	-	-	-	✓
Colour tolerance (MacAdam)	3	3	3	3
Lifetime	50,000 h	50,000	50,000 h	72,000 h
Light distribution	Extensive	Extensive	Extensive	Extensive
Light distribution				
Ambient temperature	-20°C to +25°C -20°C to +25°C		-20°C to +25°C	-20°C to +25°C
Protection class	SK I SK I		SK I	SK I
protection grade	IP 65 IP 65		IP 65	IP 65
Shock-resistant PMMA diffuser	IK 03 IK 03		IK 03	IK 03
Shock-resistant PC diffuser	IK 07 IK 07		IK 07	IK 07
ENEC and VDE certified	✓ -		✓	-
HACCP certified	✓ ✓		✓	✓
D marking	✓ ✓		✓	✓
Catalogue page	13 14		15	16



PAC-D AI LED moisture-proof luminaire for agriculture & industry	PAC-D MaXX LED moisture-proof luminaire for rooms and halls with high ceilings	PAC-D MaXX Focus LED moisture-proof luminaire for shelf systems and aisles	LZP LZP HT LED moisture-proof luminaire for use in harsh environments
Ceiling or wall mounting	Ceiling or wall mounting	Ceiling or wall mounting	Ceiling or wall mounting
<ul style="list-style-type: none"> • Stables and sheds • Agricultural holdings • Timber and paper industry • Industrial buildings and warehouses that require a high protection grade • Production and storage facilities in the food industry 	<ul style="list-style-type: none"> • Logistics buildings and warehouses • Industrial manufacturing and production sites • Production and storage facilities in the food industry • Exhibition halls 	<ul style="list-style-type: none"> • Narrow rooms, corridors and other passageways • High-bay warehouses • High-ceilinged commercial buildings • Production and storage facilities in the food industry 	<ul style="list-style-type: none"> • Underground and multi-storey car parks • Workshops, warehouses and assembly halls • Industrial buildings and warehouses that require a high protection grade • Production and storage facilities in the food industry • LZP HT: cold stores
Approved for use indoors or in covered outdoor areas.	Approved for use indoors or in covered outdoor areas.	Approved for use indoors or in covered outdoor areas.	Approved for use indoors and in protected and unprotected outdoor areas.
-	-	-	- -
✓	✓	✓	✓ ✓
available on request	available on request	available on request	✓ available on request
✓	✓	✓	✓ -
✓	✓	✓	✓ ✓
-	-	-	✓ -
available on request	available on request	available on request	- -
✓	✓	✓	✓ ✓
available on request	available on request	available on request	- -
3	3	3	3 3
50,000 h	60,000 h	60,000 h	50,000 h 70,000 h
Extensive	Extensive	Intense	Extensive Extensive
			 
-20°C to +35°C	-20°C to +35°C	-20°C to +35°C	-20°C to +35°C -40°C to +55°C
SK I	SK I	SK I	SK I SK I
IP 69K	IP 65	IP 65	IP 66 IP 66
IK 03	IK 02	IK 02	- -
IK 07	-	-	IK 07 IK 07
-	-	-	- -
✓	✓	✓	✓ ✓
✓	✓	✓	✓ ✓
22 - 23	92	92	17 24 - 25





Surface-mounted luminaires

 Multilumen	 Multilumen	 Multilumen
AOT ML 30	AOT Mini ML 31	Euro-Line ML 32
 Multilumen		 UGR < 19
Euro-Line Mini ML 33	DeSpl 34	Quadra-P 35
 Multilumen UGR < 19	 UGR < 19 NEW	
LUX ML LUX 36 - 37	LUX ASYM 39	

We offer a wide range of high-quality surface-mounted luminaires that are suitable for diverse applications, including car parks, corridors, stairwells, containers and ancillary rooms as well as the retail food trade.



NEW: Multilumen function

Luminaire housing made of white lacquered steel. Polycarbonate (PC) latch, white. Angular, smooth opal acrylic diffuser (PMMA). 3-pin push-fit connector with plug-in contact, loop-through possible.

Suitable for wall or ceiling mounting in reception areas, treatment rooms, canteens and lounges.

- ☛ **New: Multilumen function**
- ☛ **Classic design with clean lines**
- ☛ **Sustainable product thanks to replaceable LED module**
- ☛ **AC/DC capable**

- ☛ Long LED lifetime – 50,000 h for L80/B10
- ☛ Colour tolerance (initial MacAdam) 3
- ☛ Foam profile seal
- ☛ Available in three lengths
- ☛ Optionally available with DALI

Type	Version	Colour temp. (K)	Luminous flux (Lm)	System power (W)	LED lifetime	L	E	PU	Article No.	Gross €/pcs.		
AOT ML	650	Basic	3000	2900 / 1800	27 / 16	50,000 h	L80/B10	650	460	150	7010 3050	75.50
			4000	3000 / 1900	27 / 16	50,000 h	L80/B10	650	460	150	7010 3060	75.50
	1250	Basic	3000	4800 / 3000	42 / 27	50,000 h	L80/B10	1260	900	200	7011 3050	114.60
			4000	5000 / 3200	42 / 27	50,000 h	L80/B10	1260	900	200	7011 3060	114.60
	1550	Basic	3000	6300 / 4800	55 / 43	50,000 h	L80/B10	1560	1200	100	7012 3050	135.30
			4000	6600 / 5100	55 / 43	50,000 h	L80/B10	1560	1200	100	7012 3060	135.30

For suitable replacement diffusers and luminaire housings see page 114+

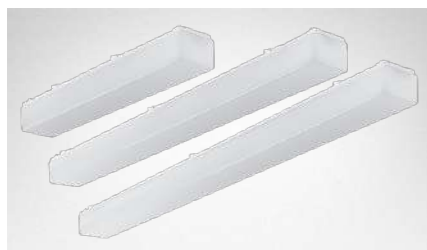
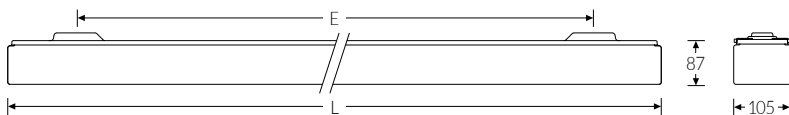

AOT ML 650, 1250, 1550



AOT Mini ML

LED DIFFUSER SURFACE-MOUNTED LUMINAIRE

CE  IK02 IP50



NEW: Multilumen function

Luminaire housing made of profiled steel, white with plastic end pieces. Angular, smooth opal acrylic diffuser (PMMA). 3-pin push-fit connector with plug-in contact, loop-through possible.

Suitable for wall or ceiling mounting in reception areas, treatment rooms, canteens and lounges.

- 🔌 **New: Multilumen function**
- 🔌 **Classic design with clean lines**
- 🔌 **Low-profile design**
- 🔌 **Sustainable product thanks to replaceable LED module**
- 🔌 **Luminous efficacy up to 128 Lm/W (eligible for funding)**
- 🔌 **AC/DC capable**

- 🔌 Long LED lifetime – 50,000 h for L80/B10
- 🔌 Colour tolerance (initial MacAdam) 3
- 🔌 Foam profile seal
- 🔌 Available in three lengths

Type	Version	Colour temp. (K)	Luminous flux (Lm)	System power (W)	LED lifetime	L	E	PU	Article No.	Gross €/pcs.		
AOT Mini ML	600	Basic	3000	2900 / 1900	27 / 16	50,000 h	L80/B10	605	490	300	7005 0015	75.50
			4000	3100 / 2000	27 / 16	50,000 h	L80/B10	605	490	300	7005 0055	75.50
	1200	Basic	3000	4900 / 3100	42 / 27	50,000 h	L80/B10	1205	900	200	7005 0105	114.60
			4000	5100 / 3300	42 / 27	50,000 h	L80/B10	1205	900	200	7005 0155	114.60
	1500	Basic	3000	6500 / 5200	55 / 43	50,000 h	L80/B10	1505	1100	150	7005 0205	135.30
			4000	6800 / 5500	55 / 43	50,000 h	L80/B10	1505	1100	150	7005 0255	135.30

For suitable replacement diffusers and luminaire housings see page 114+

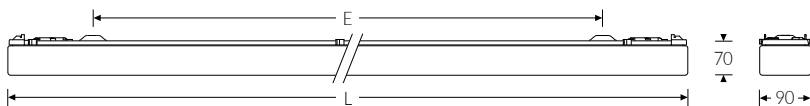

Euro-Line ML

LED DIFFUSER SURFACE-MOUNTED LUMINAIRE

CE IK02 IP50



NEW: Multilumen function

Luminaire housing made of white lacquered steel. Polycarbonate (PC) latch, white. Smooth opal acrylic diffuser (PMMA) with bevelled edges. 3-pin push-fit connector with plug-in contact, loop-through possible.

Suitable for wall or ceiling mounting in reception areas, treatment rooms, canteens and lounges.

- Long LED lifetime – 50,000 h for L80/B10
- Colour tolerance (initial MacAdam) 3
- Foam profile seal
- Available in three lengths

- New: Multilumen function**
- Bevelled edges for a timeless design**
- Sustainable product thanks to replaceable LED module**
- AC/DC capable**

Type	Version	Colour temp. (K)	Luminous flux (Lm)	System power (W)	LED lifetime	L	E	PU	Article No.	Gross €/pcs.		
Euro-Line ML	650	Basic	3000	2900 / 1800	27 / 16	50,000 h	L80/B10	660	460	150	7010 3150	74.50
			4000	3000 / 1900	27 / 16	50,000 h	L80/B10	660	460	150	7010 3160	74.50
	1250	Basic	3000	4800 / 3000	42 / 27	50,000 h	L80/B10	1260	900	100	7011 3150	113.50
			4000	5000 / 3200	42 / 27	50,000 h	L80/B10	1260	900	100	7011 3160	113.50
	1550	Basic	3000	6300 / 4800	55 / 43	50,000 h	L80/B10	1560	1200	100	7012 3150	135.30
			4000	6600 / 5100	55 / 43	50,000 h	L80/B10	1560	1200	100	7012 3160	135.30

For suitable replacement diffusers and luminaire housings see page 114+

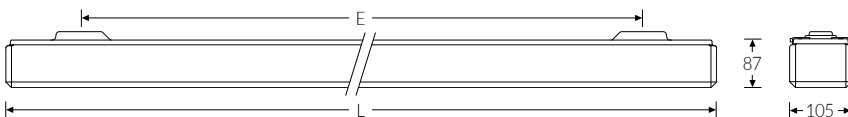

Euro-Line ML 650, 1250, 1550



Euro-Line Mini ML

LED DIFFUSER SURFACE-MOUNTED LUMINAIRE

CE  IK02 IP50



NEW: Multilumen function

Luminaire housing made of profiled steel, white with plastic end pieces. Smooth opal acrylic diffuser (PMMA) with bevelled edges. 3-pin push-fit connector with plug-in contact, loop-through possible.

Suitable for wall or ceiling mounting in reception areas, treatment rooms, canteens and lounges.

- 🔌 **New: Multilumen function**
- 🔌 **Bevelled edges for a timeless design**
- 🔌 **Low-profile design**
- 🔌 **Sustainable product thanks to replaceable LED module**
- 🔌 **Luminous efficacy up to 128 Lm/W (eligible for funding)**
- 🔌 **AC/DC capable**

- 🔌 Long LED lifetime – 50,000 h for L80/B10
- 🔌 Colour tolerance (initial MacAdam) 3
- 🔌 Foam profile seal
- 🔌 Available in three lengths

Type	Version	Colour temp. (K)	Luminous flux (Lm)	System power (W)	LED lifetime	L	E	PU	Article No.	Gross €/pcs.		
Euro-Line Mini ML	600	Basic	3000	2900 / 1900	27 / 16	50,000 h	L80/B10	615	490	300	7005 0010	75.50
			4000	3100 / 2000	27 / 16	50,000 h	L80/B10	615	490	300	7005 0050	75.50
	1200	Basic	3000	4900 / 3100	42 / 27	50,000 h	L80/B10	1215	900	200	7005 0100	114.60
			4000	5100 / 3300	42 / 27	50,000 h	L80/B10	1215	900	200	7005 0150	114.60
	1500	Basic	3000	6500 / 5200	55 / 43	50,000 h	L80/B10	1515	1100	150	7005 0200	135.30
			4000	6800 / 5500	55 / 43	50,000 h	L80/B10	1515	1100	150	7005 0250	135.30



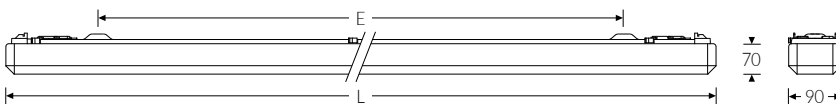

For suitable replacement diffusers and luminaire housings see page 114+





Stylish mirror luminaire with opal, angular cover made of acrylic glass (PMMA). Luminaire housing made of profiled, anodised aluminium with die-cast aluminium protective caps. Suitable for ceiling and wall mounting. Suitable for bathrooms, changing rooms and sanitary rooms (e.g. as a mirror luminaire) as well as cloakrooms and corridors.







-  **Luminous efficacy up to 128 Lm/W** (eligible for funding)
-  **Homogeneous surface illumination**
-  **Integrated power supply unit**
-  **Protection grade IP 44**

Type		Colour temp. (K)	Luminous flux (Lm)	System power (W)	LED lifetime	L	W	PU	Article No.	Gross €/pcs.
DeSpl	600	2700	1900	16	50,000 h L80/B20	600	40	100	6626 1000	229.00
		3000	1900	16	50,000 h L80/B20	600	40	100	6626 1050	229.00
		4000	2000	16	50,000 h L80/B20	600	40	100	6626 1100	229.00
	1200	2700	3800	32	50,000 h L80/B20	1200	40	100	6626 1150	277.00
		3000	3800	32	50,000 h L80/B20	1200	40	100	6626 1200	277.00
		4000	4100	32	50,000 h L80/B20	1200	40	100	6626 1250	277.00



Optionally available:

-  Other lengths
-  Round cover
-  Integrated switch
-  White or black housing
-  DALI dimmable



Quadra-P

LED LOUVRE CEILING-MOUNTED LUMINAIRE

CE IP20 UGR < 19



Sturdy housing made of steel, white. Double parabolic louvres in high-gloss aluminium, reduces glare to provide optimal lighting for workstations with PC monitors – in offices and commercial or social spaces.

- ☛ Long LED lifetime – 50,000 h for L80/B10
- ☛ Colour tolerance (initial MacAdam) 3
- ☛ Ambient temperature from +10°C to +40°C

☛ **Simple 1:1 replacement for conventional surface-mounted luminaires**

☛ **Unified Glare Rating (UGR) < 19**

☛ **Elegant, low-profile design**

Type	Module	Colour temp. (K)	Luminous flux (Lm)	System power (W)	LED lifetime	L	W	E	PU	Article No.	Gross €/pcs.
Quadra-P	1200 x 300	4000	5100	47	50,000 h L80/B10	1200	300	1000	50	88030050	219.00
	1500 x 300	4000	6700	60	50,000 h L80/B10	1500	300	1300	50	88030065	285.00

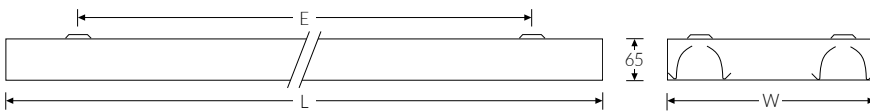

LUX ML

LED LOUVRE CEILING-MOUNTED LUMINAIRE

CE IK02 IP20 UGR < 19

Glare-free, energy efficient, easy to install and durable.

Sturdy housing made of steel, white, low-profile design. Double parabolic louvres in highly polished aluminium for reduced glare, provides optimal lighting for workstations with PC monitors in offices and commercial or social spaces. Can be used as a surface-mounted or suspended luminaire (see accessories for suspension options).

Its high energy efficiency, ease of installation and durability make the LUX the perfect solution for new lighting installations and refurbishment projects.



- Multilumen function**
- Unified Glare Rating (UGR) < 19**
- Luminous efficacy up to 139 Lm/W** (eligible for funding)
- Simple 1:1 replacement for conventional surface-mounted luminaires**
- AC/DC capable (LUX ML)**

- Uniform light distribution in the room
- Long LED lifetime – up to 50,000 h for L80/B10
- Ambient temperature from –15°C to +30°C
- LUX available with DALI

LUX with Multilumen function

Type	Version	Colour temp. (K)	Luminous flux (Lm)	System power (W)	LED lifetime	L	W	E	PU	Article No.	Gross €/pcs.		
LUX ML	1/1200	Basic	3000	4300 / 2400	39 / 18	50,000 h	L80/B50	1210	155	900	40	8486 1385	145.00
			4000	4500 / 2500	39 / 18	50,000 h	L80/B50	1210	155	900	40	8486 1370 •	145.00
	2/1200	Basic	3000	4600 / 2800	39 / 21	50,000 h	L80/B50	1210	240	900	40	8486 4050	170.00
			4000	4800 / 2900	39 / 21	50,000 h	L80/B50	1210	240	900	40	8486 4000 •	170.00
	1/1500	Basic	3000	5800 / 2900	50 / 24	50,000 h	L80/B50	1510	155	1200	40	8486 1590	149.00
			4000	6000 / 3000	50 / 24	50,000 h	L80/B50	1510	155	1200	40	8486 1575 •	149.00
	2/1500	Basic	3000	6700 / 4200	58 / 33	50,000 h	L80/B50	1510	240	1200	40	8486 4510	194.00
			4000	7000 / 4400	58 / 33	50,000 h	L80/B50	1510	240	1200	40	8486 4500 •	194.00

• available ex stock



Multilumen technology

The luminaire can be operated with various luminous flux levels.



Eligible for funding

The perfect solution for new installations and refurbishment projects.



Type	Version	Colour temp. (K)	Luminous flux (Lm)	System power (W)	LED lifetime	L	W	E	PU	Article No.	Gross €/pcs.	
LUX	1/1200	Basic	4000	2300	19	50,000 h L80/B10	1210	155	900	40	8486 1250 •	142.00
	2/1200	Basic	4000	4500	37	50,000 h L80/B10	1210	240	900	40	8486 1255 •	164.70
LUX	1/1500	Basic	4000	3400	30	50,000 h L80/B10	1510	155	1200	40	8486 1550 •	147.00
	2/1500	Basic	4000	7200	58	50,000 h L80/B10	1510	240	1200	40	8486 1555 •	189.70

• available ex stock

LUX with DALI dimmable

Type	Version	Colour temp. (K)	Luminous flux (Lm)	System power (W)	LED lifetime	L	W	E	PU	Article No.	Gross €/pcs.	
LUX	1/1200	DALI	4000	2300	19	50,000 h L80/B10	1210	155	900	40	8486 1265	170.00
	2/1200	DALI	4000	4500	37	50,000 h L80/B10	1210	240	900	40	8486 1275	195.00
LUX	1/1500	DALI	4000	3400	30	50,000 h L80/B10	1510	155	1200	40	8486 1545	187.30
	2/1500	DALI	4000	7200	58	50,000 h L80/B10	1510	240	1200	40	8486 1565	222.50

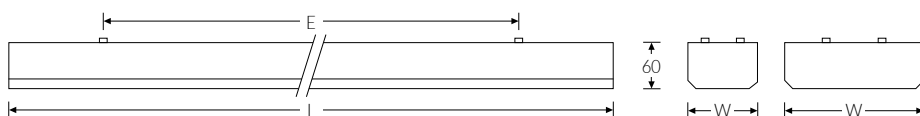

Accessories / Installation components

Suitable for LUX series, 1200 and 1500 mm length.



Type	Article No.	Gross €/pcs.
Cable suspension set* (4-point)	3596 2800	46.30

*Set consisting of 4 freely adjustable suspension cables (max. length 3 m) and the matching ceiling fixings.



SUSTAINABLE

Lighting. Upgrades. Refurbishment.



FLUOLITE

COMPETENCE IN
LIGHT & LUMINAIRES

NEW

LUX ASYM

LED CEILING-MOUNTED LUMINAIRE

CE \oplus IK02 IP20 UGR < 19



Light, exactly where you need it.

LUX with asymmetrical light distribution, dimmable. Suitable for illuminating whiteboards and blackboards in classrooms, for example.

Sturdy housing made of steel, white, low-profile design. Asymmetrical reflector for wall lighting. Can be used as a surface-mounted or suspended luminaire (suspension available on request).

- ☛ Long LED lifetime – up to 50,000 h for L80/B10
- ☛ Colour tolerance (initial MacAdam) 3
- ☛ Ambient temperature from -15°C to +30°C
- ☛ DALI dimmable

☛ **Asymmetrical light distribution**

☛ **Low-profile, timeless design**

☛ **Unified Glare Rating (UGR) < 19**

☛ **Luminous efficacy up to 138 Lm/W** **(eligible for funding)**

Type	Version	Colour temp. (K)	Luminous flux (Lm)	System power (W)	LED lifetime	L	H	E1	E2	PU	Article No.	Gross €/pcs.		
LUX ASYM	1/1200	DALI	4000	4800	38	50,000 h	L80/B10	1195	60	1000	1100	40	8486 1350	175.00
	1/1500	DALI	4000	6500	47	50,000 h	L80/B10	1486	67	1000	1100	40	8486 1546	195.00

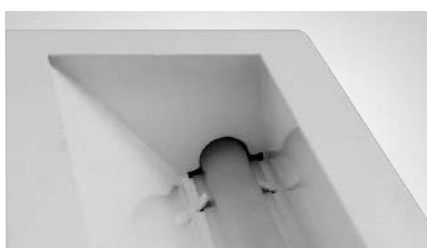
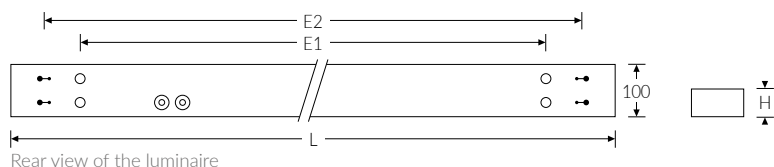

LUX ASYM with optimum light control



Asymmetrical lighting means the light beam is directed in a specific direction as needed, whereby the beam type is ideal for shelf lighting, accent lighting and illuminating objects on walls.



LUX ASYM online:
www.fluolite.de/produkte/serie/lux





Wall and ceiling luminaires

<p>Multilumen & Multicolor</p> <p>Weiler FL Weiler-Z FL</p>	<p>Multilumen</p> <p>RKL ML 50 - 52</p> <p>Multilumen</p> <p>RKL-Z ML 53 - 55</p>	
<p>RKL-Aqua 56 - 57</p>	<p>Quadro-Lite 60</p>	<p>Rondo-Lite 61</p>

Our product range stands out thanks to its diversity. Our range of luminaires with modern designs and extremely homogeneous surface illumination also includes numerous variants equipped with cutting-edge technologies. The flexible nature of this luminaire series is underlined by its countless areas of use: living areas, stairwells, corridors, retirement and care centres, canteens, shops and shopping centres, etc.

Weiler FL | Weiler-Z FL

Highlights

Technical variants



Multilumen
Adjustable light output



Multicolor
Adjustable light colour



HF sensor
Master / Slave



DALI
With dimming function

Sustainability across the board



Eligible for funding
The perfect solution for new installations and refurbishment projects.



Made in Germany
German and European production in accordance with ISO 9001 and ISO 14001.



Sustainable
thanks to energy-efficient LED technology and replaceable components.



5-year Fluolite warranty
for luminaires with a lifetime of $\geq 50,000$ operating hours.

Sizes

Weiler FL

Ø 290 mm Ø 360 mm Ø 464 mm



Weiler-Z FL

Ø 290 mm Ø 360 mm Ø 464 mm



Dimensional drawing

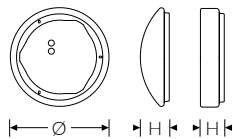

Installation options



Accessories / Installation components



Stylish shades
For a homely ambience and a cosy atmosphere (page 46–47).



Decorative rings
To enhance the appearance of the luminaire (page 57).



Cable suspension
For decorative suspension of the luminaire (page 44).

A stylish all-rounder.



MULTILUMEN

Multiple luminous flux levels in one luminaire. Ideal for adjusting the lighting quality due to specific application requirements and the prevailing conditions.

MULTICOLOR

Multiple light colours in one luminaire. The luminous flux (lumen) and light colour (Kelvin) can be adjusted independently of each other using a switch in the luminaire, even after installation.



VERSATILE ALL-ROUNDER

Visual enhancements available, including numerous designer shades and decorative rings.

LONG-LASTING AND ENERGY EFFICIENT

Economical solution thanks to high energy efficiency and a long lifetime.





MULTILUMEN AND MULTICOLOR TECHNOLOGY

Luminaire housing made of powder-coated steel, white. Domed diffuser made of opal, UV-resistant PMMA. Plug terminal. Suitable for wall, ceiling or suspended mounting.

Independently adjustable Multilumen and Multicolour functions

Sustainable product due to interchangeable components

Luminous efficacy up to 133 Lm/W (eligible for funding)

AC/DC capable

- ☛ Selectable colour temperature: 3,000 K, 3,500 K or 4,000 K
- ☛ LED lifetime – 50,000 h for L80/B10
- ☛ Colour tolerance (initial MacAdam) 3
- ☛ Loop-through possible (2 cable entries)
- ☛ Practical bayonet closure

Weiler FL with Multilumen and Multicolor function

Type	Version	Colour temp. (K)	Luminous flux (Lm)	System power (W)	LED lifetime	Ø	H	PU	Article No.	Gross €/pcs.
Weiler FL 2 ML MC	Basic	3000 / 4000	2500 / 1100	20 / 9	50,000 h L80/B10	290	85	200	7610 3450 •	51.00
	HF sensor (Master/Slave)	3000 / 4000	2500 / 1100	20 / 9	50,000 h L80/B10	290	85	200	7610 3455 •	68.50
Weiler FL 3 ML MC	Basic	3000 / 4000	3000 / 1600	24 / 12	50,000 h L80/B10	360	95	140	7611 3450 •	65.20
	HF sensor (Master/Slave)	3000 / 4000	3000 / 1600	24 / 12	50,000 h L80/B10	360	95	140	7611 3455 •	82.80
Weiler FL 4 ML MC	Basic	3000 / 4000	4700 / 3200	39 / 25	50,000 h L80/B10	464	120	60	7612 3450 •	96.00
	HF sensor (Master/Slave)	3000 / 4000	4700 / 3200	39 / 25	50,000 h L80/B10	464	120	60	7612 3455 •	114.00

Weiler FL with Multicolor function and DALI dimmable

Type	Version	Colour temp. (K)	Luminous flux (Lm)	System power (W)	LED lifetime	Ø	H	PU	Article No.	Gross €/pcs.
Weiler FL 2 MC	DALI	3000 / 4000	2500	20	50,000 h L80/B10	290	85	200	7610 4000	90.50
Weiler FL 3 MC	DALI	3000 / 4000	3000	24	50,000 h L80/B10	360	95	140	7611 4000	111.00
Weiler FL 4 MC	DALI	3000 / 4000	4700	39	50,000 h L80/B10	464	120	60	7612 4000	139.80

• available ex stock | For suitable replacement diffusers see page 111

Accessories / Installation components



Type	Article No.	Gross €/pcs.
Cable suspension Weiler/-Z FL + RKL/-Z 2, 3, 4, 6 3-point cable suspension set, galvanised wire cable. Stepless height adjustment via the wire cable holder. Cable length approx. 2.20 metres, mounting materials included.	3597 4070 •	39.80





MULTILUMEN AND MULTICOLOR TECHNOLOGY

Luminaire housing made of powder-coated steel, white. Flat cylindrical diffuser made of opal, UV-resistant PMMA. Plug terminal. Suitable for wall, ceiling or suspended mounting.

☛ **Independently adjustable Multilumen and Multicolour functions**

☛ **Sustainable product due to interchangeable components**

☛ **Luminous efficacy up to 137 Lm/W** (eligible for funding)

☛ **AC/DC capable**

- ☛ Selectable colour temperature: 3,000 K, 3,500 K or 4,000 K
- ☛ LED lifetime – 50,000 h for L80/B10
- ☛ Colour tolerance (initial MacAdam) 3
- ☛ Loop-through possible (2 cable entries)
- ☛ Practical bayonet closure

Weiler-Z FL with Multilumen and Multicolor function

Type	Version	Colour temp. (K)	Luminous flux (Lm)	System power (W)	LED lifetime	Ø	H	PU	Article No.	Gross €/pcs.
Weiler-Z FL 2 ML MC	Basic	3000 / 4000	2600 / 1200	20 / 9	50,000 h L80/B10	290	70	200	7615 3450 •	51.00
Weiler-Z FL 3 ML MC	Basic	3000 / 4000	3100 / 1700	24 / 12	50,000 h L80/B10	360	70	140	7616 3450 •	65.20
Weiler-Z FL 4 ML MC	Basic	3000 / 4000	4900 / 3400	39 / 25	50,000 h L80/B10	464	70	60	7617 3450 •	96.00
	HF sensor (Master/Slave)	3000 / 4000	4900 / 3400	39 / 25	50,000 h L80/B10	464	70	60	7617 3455 •	114.00

Weiler-Z FL with Multicolor function and DALI dimmable

Type	Version	Colour temp. (K)	Luminous flux (Lm)	System power (W)	LED lifetime	Ø	H	PU	Article No.	Gross €/pcs.
Weiler-Z FL 2 MC	DALI	3000 / 4000	2600	20	50,000 h L80/B10	290	70	200	7615 4000	90.50
Weiler-Z FL 3 MC	DALI	3000 / 4000	3100	24	50,000 h L80/B10	360	70	140	7616 4000	111.00
Weiler-Z FL 4 MC	DALI	3000 / 4000	4900	39	50,000 h L80/B10	464	70	60	7617 4000	139.80

• available ex stock | For suitable replacement diffusers see page 111

Increased flexibility thanks to our modular design concept.

During development, our goal was to use as many common components as possible throughout this family of luminaires. Thanks to the practical standardised bayonet closure, the Weiler(-Z) FL diffuser can be changed quickly and easily – even when mounted.

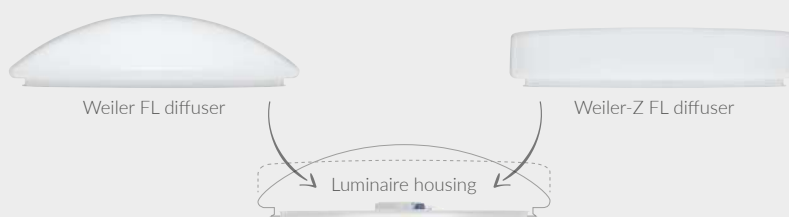



STYLISH SHADES FOR WALL AND CEILING LUMINAIRES

Enhance your interior design with our new, modern designer shades for our Weiler FL luminaire range. Discover our collection, choose from different materials, colours and sizes – all made in Germany.

As an aesthetic highlight, we can also implement custom requirements and create a shade that is perfectly adapted to your needs. For a unique lighting concept of the highest quality – from Fluolite.



Diverse materials and numerous designs

Our carefully selected materials and colours offer a multitude of possible uses. Choose from various material and colour combinations for additional flexibility.

Our team will be happy to assist you with the selection and design of your shade.

Tool-free installation

The shade's retaining ring is simply installed on the lower part of the luminaire.

The diffuser is then fixed in place using the bayonet closure. Finished!



Colour overview: Chintz

Fine cotton fabric in silky matt colours | > 30 colours available on request.

		suitable for Weiler/-Z FL 2 (shade Ø x H) 400 x 140	suitable for Weiler/-Z FL 3 (shade Ø x H) 460 x 160	suitable for Weiler/-Z FL 4 (shade Ø x H) 580 x 190
Chintz White		Art. No. 3605 6000 € 135.00	Art. No. 3605 6010 € 145.00	Art. No. 3605 6020 € 160.00
Chintz Blue		Art. No. 3605 6001 € 135.00	Art. No. 3605 6011 € 145.00	Art. No. 3605 6021 € 160.00
Chintz Green		Art. No. 3605 6002 € 135.00	Art. No. 3605 6012 € 145.00	Art. No. 3605 6022 € 160.00
Chintz Beige		Art. No. 3605 6003 € 135.00	Art. No. 3605 6013 € 145.00	Art. No. 3605 6023 € 160.00
Chintz Pink		Art. No. 3605 6004 € 135.00	Art. No. 3605 6014 € 145.00	Art. No. 3605 6024 € 160.00
Chintz Silver-Grey		Art. No. 3605 6005 € 135.00	Art. No. 3605 6015 € 145.00	Art. No. 3605 6025 € 160.00
Chintz Meringue		Art. No. 3605 6006 € 135.00	Art. No. 3605 6016 € 145.00	Art. No. 3605 6026 € 160.00

Colour overview: Linen

Robust faux-linen fabric | > 20 colours available on request.

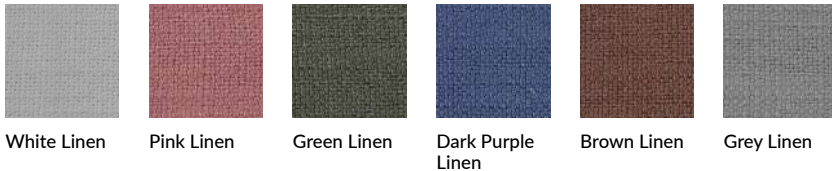

Colour overview: Foil

Shade with a metallic foil finish.



Colour overview: Gold / Silver Leaf, transparent

Genuine gold/silver leaf laid on transparent foil and varnished for protection.



 Shade material that complies with fire protection class B1 is optionally available.



RKL | RKL-Z | RKL-Aqua Highlights

Sustainability across the board



Eligible for funding

The perfect solution for new installations and refurbishment projects.



Sustainable

thanks to energy-efficient LED technology and replaceable components.



Made in Germany

German and European production in compliance with ISO 9001 and ISO 14001.



5-year Fluolite warranty

for luminaires with a lifetime of $\geq 50,000$ operating hours.

Protection grade

IP40

RKL | RKL-Z

Protected against foreign bodies

IP65

RKL-Aqua

Dust-proof / protected against jets of water

Shock resistance

IK02

Acrylic (PMMA)

- Very good UV resistance
- Resistant to greases, oils, acids and alkaline cleaners

IK06

Polycarbonate (PC)

- Excellent shock resistance
- High rigidity

Technical variants



Multilumen

Adjustable light output



3h emergency lighting

With emergency lighting function



HF sensor

Master / Slave



DALI

With dimming function

Other variants available on request.

Installation options

Wall



Ceiling



Suspended



Beam type

Extensive



Accessories / Installation components



Decorative rings

To enhance the appearance of the luminaire (page 57).



Cable suspension

For decorative suspension of the luminaire (page 44).

Increased flexibility thanks to our modular design concept.

During development, our goal was to use as many common components as possible throughout this family of luminaires. Thanks to the practical standardised bayonet closure, the RKL(-Z) diffuser can be changed quickly and easily – even when mounted.





RKL | RKL-Z



Suitable for indoor use.

Very high efficiency of up to 142 Lm/W.

Protected against the ingress of foreign bodies.

Two diffuser materials (PC and PMMA) and two shock resistance levels (IK 02 and IK 06).

Four sizes:



300 mm



375 mm
370 mm



475 mm
460 mm



600 mm
580 mm

RKL-Aqua



Suitable for use indoors and in covered outdoor areas.

Very high efficiency of up to 142 Lm/W.

Protected against dust and jets of water.

Two diffuser materials (PC and PMMA) and two shock resistance levels (IK 02 and IK 06).

Three sizes:



300 mm



375 mm



475 mm











NEW: Multilumen function

Unobtrusive design in numerous variants.

Thanks to its unobtrusive appearance, the RKL luminaire series is highly versatile. It is ideal for corridors and stairwells, offices and educational establishments, as well as healthcare and nursing facilities.

Luminaire housing made of steel, white. Domed diffuser made of textured acrylic (PMMA), translucent opal. Suitable for wall and ceiling mounting. The diffuser is securely attached using spring clips. Plug terminal.

-  Sustainable product due to interchangeable components
-  Luminous efficacy up to 142 Lm/W **(eligible for funding)**
-  Loop-through possible (2 cable entries)
-  AC/DC capable
-  Diffuser optionally available in UV-resistant PMMA or high-impact PC to IK 06

-  Long LED lifetime – 50,000 h for L80/B10
-  Colour tolerance (initial MacAdam) 3
-  Variants with HF sensor + 3 h emergency lighting or changeover switch available

RKL 2 with Multilumen function

Type	Version	Colour temp. (K)	Luminous flux (Lm)	System power (W)	LED lifetime	Ø	H	PU	Article No.	Gross €/pcs.
RKL 2 ML (PMMA / IK 02)	Basic	3000	2400 / 1000	20 / 9	50,000 h L80/B10	300	105	175	7510 1800 •	61.00
		4000	2500 / 1100	20 / 9	50,000 h L80/B10	300	105	175	7510 1805 •	61.00
	HF sensor (Master/Slave)	3000	2400 / 1000	20 / 9	50,000 h L80/B10	300	105	175	7510 1820 •	115.50
		4000	2500 / 1100	20 / 9	50,000 h L80/B10	300	105	175	7510 1825 •	115.50
RKL 2 PC ML (PC / IK 06)	Basic	3000	2400 / 1000	20 / 9	50,000 h L80/B10	300	105	175	7510 1850	66.30
		4000	2500 / 1100	20 / 9	50,000 h L80/B10	300	105	175	7510 1855	66.30

RKL 3 with Multilumen function

Type	Version	Colour temp. (K)	Luminous flux (Lm)	System power (W)	LED lifetime	Ø	H	PU	Article No.	Gross €/pcs.
RKL 3 ML (PMMA / IK 02)	Basic	3000	2900 / 1500	24 / 12	50,000 h L80/B10	375	125	100	7511 1714 •	72.30
		4000	3100 / 1700	24 / 12	50,000 h L80/B10	375	125	100	7511 1717 •	72.30
	HF sensor (Master/Slave)	3000	2900 / 1500	24 / 12	50,000 h L80/B10	375	125	100	7511 1630 •	124.30
		4000	3100 / 1700	24 / 12	50,000 h L80/B10	375	125	100	7511 1631 •	124.30
	3h emergency lighting	3000	2900 / 1500	24 / 12	50,000 h L80/B10	375	125	100	7511 1627	290.00
		4000	3100 / 1700	24 / 12	50,000 h L80/B10	375	125	100	7511 1628	290.00
RKL 3 PC ML (PC / IK 06)	Basic	3000	2900 / 1500	24 / 12	50,000 h L80/B10	375	125	100	7511 1721	79.80
		4000	3100 / 1700	24 / 12	50,000 h L80/B10	375	125	100	7511 1722	79.80

• available ex stock | For suitable replacement diffusers see page 111

RKL 4 with Multilumen function

Type	Version	Colour temp. (K)	Luminous flux (Lm)	System power (W)	LED lifetime	Ø	H	PU	Article No.	Gross €/pcs.		
RKL 4 ML (PMMA / IK 02)	Basic	3000	3200 / 1800	26 / 14	50,000 h	L80/B10	475	150	50	7512 1700 •	80.00	
		4000	3400 / 1900	26 / 14	50,000 h	L80/B10	475	150	50	7512 1710 •	80.00	
		3000	4900 / 3300	39 / 25	50,000 h	L80/B10	475	150	50	7512 4263 •	113.60	
		4000	5200 / 3600	39 / 25	50,000 h	L80/B10	475	150	50	7512 4261 •	113.60	
	HF sensor (Master/Slave)	3000	3200 / 1800	26 / 14	50,000 h	L80/B10	475	150	50	7512 1740 •	120.80	
		4000	3400 / 1900	26 / 14	50,000 h	L80/B10	475	150	50	7512 1750 •	120.80	
		3000	4900 / 3300	39 / 25	50,000 h	L80/B10	475	150	50	7512 4279 •	146.30	
		4000	5200 / 3600	39 / 25	50,000 h	L80/B10	475	150	50	7512 4277 •	146.30	
	3h emergency lighting	3000	3200 / 1800	26 / 14	50,000 h	L80/B10	475	150	50	7512 1760	285.00	
		4000	3400 / 1900	26 / 14	50,000 h	L80/B10	475	150	50	7512 1770	285.00	
		3000	4900 / 3300	39 / 25	50,000 h	L80/B10	475	150	50	7512 4283	321.80	
		4000	5200 / 3600	39 / 25	50,000 h	L80/B10	475	150	50	7512 4281	321.80	
	RKL 4 PC ML (PC / IK 06)	Basic	3000	3200 / 1800	26 / 14	50,000 h	L80/B10	475	150	50	7512 1720	82.00
			4000	3400 / 1900	26 / 14	50,000 h	L80/B10	475	150	50	7512 1730	82.00
			3000	4900 / 3300	39 / 25	50,000 h	L80/B10	475	150	50	7512 4269	118.60
			4000	5200 / 3600	39 / 25	50,000 h	L80/B10	475	150	50	7512 4266	118.60

RKL 6 with Multilumen function

Type	Version	Colour temp. (K)	Luminous flux (Lm)	System power (W)	LED lifetime	Ø	H	PU	Article No.	Gross €/pcs.	
RKL 6 ML (PMMA / IK 02)	Basic	3000	10,400 / 8200	80 / 63	50,000 h	L80/B10	600	165	28	7513 1800	170.30
		4000	10,900 / 8700	80 / 63	50,000 h	L80/B10	600	165	28	7513 1810	170.30
	HF sensor (Master/Slave)	3000	10,400 / 8200	80 / 63	50,000 h	L80/B10	600	165	28	7513 1840	196.80
		4000	10,900 / 8700	80 / 63	50,000 h	L80/B10	600	165	28	7513 1850	196.80
	3h emergency lighting	3000	10,400 / 8200	80 / 63	50,000 h	L80/B10	600	165	28	7513 1820	391.80
		4000	10,900 / 8700	80 / 63	50,000 h	L80/B10	600	165	28	7513 1830	391.80

RKL 6

Type	Version	Colour temp. (K)	Luminous flux (Lm)	System power (W)	LED lifetime	Ø	H	PU	Article No.	Gross €/pcs.		
RKL 6 (PMMA / IK 02)	Basic	3000	3600	30	50,000 h	L80/B10	600	165	28	7513 1642 •	142.80	
		4000	3700	30	50,000 h	L80/B10	600	165	28	7513 1652 •	142.80	
		3000	5100	45	50,000 h	L80/B10	600	165	28	7513 1687 •	151.90	
		4000	5300	45	50,000 h	L80/B10	600	165	28	7513 1671 •	151.90	
	HF sensor (Master/Slave)	3000	3400	30	50,000 h	L80/B10	600	165	28	7513 1645	190.50	
		4000	3600	30	50,000 h	L80/B10	600	165	28	7513 1646	190.50	
		3000	5100	45	50,000 h	L80/B10	600	165	28	7513 1688	193.50	
		4000	5300	45	50,000 h	L80/B10	600	165	28	7513 1680	193.50	
	3h emergency lighting	3000	5100	47	50,000 h	L80/B10	600	165	28	7513 1686	391.80	
		4000	5200	47	50,000 h	L80/B10	600	165	28	7513 1685	391.80	
	RKL 6 (PC / IK 06)	Basic	3000	5100	45	50,000 h	L80/B10	600	165	28	7513 1720	157.30
			4000	5300	45	50,000 h	L80/B10	600	165	28	7513 1725	157.30

• available ex stock | For suitable replacement diffusers see page 111

RKL with DALI dimmable

Type	Version	Colour temp. (K)	Luminous flux (Lm)	System power (W)	LED lifetime	Ø	H	PU	Article No.	Gross €/pcs.
RKL 2 (PMMA / IK 02)	DALI	3000	2400	20	50,000 h L80/B10	300	105	175	7510 1730	106.00
		4000	2500	20	50,000 h L80/B10	300	105	175	7510 1735	106.00
RKL 3 (PMMA / IK 02)	DALI	3000	2900	24	50,000 h L80/B10	375	125	100	7511 1609	127.50
		4000	3100	24	50,000 h L80/B10	375	125	100	7511 1610	127.50
RKL 4 (PMMA / IK 02)	DALI	3000	3200	26	50,000 h L80/B10	475	150	50	7512 1800	132.50
		4000	3400	26	50,000 h L80/B10	475	150	50	7512 1810	132.50
		3000	4500	37	50,000 h L80/B10	475	150	50	7512 4275	145.00
		4000	4800	37	50,000 h L80/B10	475	150	50	7512 4272	145.00
RKL 6 (PMMA / IK 02)	DALI	3000	5100	45	50,000 h L80/B10	600	165	28	7513 1689	200.00
		4000	5300	45	50,000 h L80/B10	600	165	28	7513 1676	200.00
		3000	10,400	80	50,000 h L80/B10	600	165	28	7513 1860	239.00
		4000	10,900	80	50,000 h L80/B10	600	165	28	7513 1870	239.00

• available ex stock | For suitable replacement diffusers see page 111

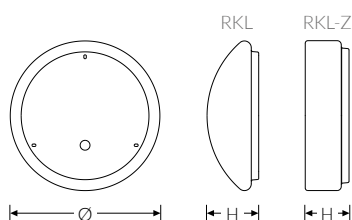

RKL online:
www.fluolite.de/produkte/serie/rkl



Technical lighting data and light distribution graphs

The Fluolite luminaire data in Eulumdat format (*.LDT) is available on our website – see the product pages for the respective luminaires. Fluolite has been a member of RELUX for several years. To help you design your lighting solution, our luminaire data can therefore also be found on the software manufacturer's website.

RELUX®



www.relux.com/de/search/luminaires/fluolite/DE



RKL-Z ML

LED WALL AND CEILING LUMINAIRE



NEW: Multilumen function

Multiple luminous flux levels in one luminaire. Ideal for adapting the lighting quality due to specific application requirements and the prevailing conditions.

The perfect choice for corridors and stairwells, offices and educational establishments, as well as healthcare and nursing facilities.

Luminaire housing made of steel, white. Flat cylindrical diffuser made of opal, UV-resistant PMMA. The diffuser is securely attached using spring clips. Plug terminal. Suitable for wall and ceiling mounting or suspended mounting via 3-point cable suspension.

- ☛ Sustainable product due to interchangeable components
- ☛ Luminous efficacy up to 142 Lm/W (eligible for funding)
- ☛ AC/DC capable
- ☛ Diffuser optionally available in UV-resistant PMMA or high-impact PC to IK 06

- ☛ Long LED lifetime – 50,000 h for L80/B10
- ☛ Colour tolerance (initial MacAdam) 3
- ☛ Loop-through possible (2 cable entries)
- ☛ Variants with HF sensor + 3 h emergency lighting available

RKL-Z 2 with Multilumen function

Type	Version	Colour temp. (K)	Luminous flux (Lm)	System power (W)	LED lifetime	Ø	H	PU	Article No.	Gross €/pcs.
RKL-Z 2 ML (PMMA / IK 02)	Basic	3000	2400 / 1000	20 / 9	50,000 h L80/B10	300	85	175	7515 1800 •	61.00
		4000	2500 / 1100	20 / 9	50,000 h L80/B10	300	85	175	7515 1805 •	61.00
	HF sensor (Master/Slave)	3000	2400 / 1000	20 / 9	50,000 h L80/B10	300	85	175	7515 1820 •	115.50
		4000	2500 / 1100	20 / 9	50,000 h L80/B10	300	85	175	7515 1825 •	115.50
RKL-Z 2 PC ML (PC / IK 06)	Basic	3000	2400 / 1000	20 / 9	50,000 h L80/B10	300	85	175	7515 1850	66.30
		4000	2500 / 1100	20 / 9	50,000 h L80/B10	300	85	175	7515 1855	66.30

RKL-Z 3 with Multilumen function

Type	Version	Colour temp. (K)	Luminous flux (Lm)	System power (W)	LED lifetime	Ø	H	PU	Article No.	Gross €/pcs.
RKL-Z 3 ML (PMMA / IK 02)	Basic	3000	2900 / 1500	24 / 12	50,000 h L80/B10	370	85	100	7516 1519 •	72.30
		4000	3100 / 1700	24 / 12	50,000 h L80/B10	370	85	100	7516 1526 •	72.30
	HF sensor (Master/Slave)	3000	2900 / 1500	24 / 12	50,000 h L80/B10	370	85	100	7516 1531 •	124.30
		4000	3100 / 1700	24 / 12	50,000 h L80/B10	370	85	100	7516 1532 •	124.30
	3h emergency lighting	3000	2900 / 1500	24 / 12	50,000 h L80/B10	370	85	100	7516 1608	290.00
		4000	3100 / 1700	24 / 12	50,000 h L80/B10	370	85	100	7516 1609	290.00
RKL-Z 3 PC ML (PC / IK 06)	Basic	3000	2900 / 1500	24 / 12	50,000 h L80/B10	370	85	100	7516 1552	79.80
		4000	3100 / 1700	24 / 12	50,000 h L80/B10	370	85	100	7516 1556	79.80

• available ex stock | For suitable replacement diffusers see page 112

MADE IN GERMANY

Regional production, tailored to our customers' needs. Since 1926.



FLUOLITE

COMPETENCE IN
LIGHT & LUMINAIRES

RKL-Z 4 with Multilumen function

Type	Version	Colour temp. (K)	Luminous flux (Lm)	System power (W)	LED lifetime	Ø	H	PU	Article No.	Gross €/pcs.
RKL-Z 4 ML (PMMA / IK 02)	Basic	3000	3200 / 1800	26 / 14	50,000 h L80/B10	460	95	50	7517 1750 •	82.00
		4000	3400 / 1900	26 / 14	50,000 h L80/B10	460	95	50	7517 1760 •	82.00
		3000	4900 / 3300	39 / 25	50,000 h L80/B10	460	95	50	7517 1628 •	110.80
		4000	5200 / 3600	39 / 25	50,000 h L80/B10	460	95	50	7517 1651 •	110.80
	HF sensor (Master/Slave)	3000	3200 / 1800	26 / 14	50,000 h L80/B10	460	95	50	7517 1770 •	130.50
		4000	3400 / 1900	26 / 14	50,000 h L80/B10	460	95	50	7517 1780 •	130.50
		3000	4900 / 3300	39 / 25	50,000 h L80/B10	460	95	50	7517 1656 •	157.50
		4000	5200 / 3600	39 / 25	50,000 h L80/B10	460	95	50	7517 1653 •	157.50
	3h emergency lighting	3000	3200 / 1800	26 / 14	50,000 h L80/B10	460	95	50	7517 1800	285.00
		4000	3400 / 1900	26 / 14	50,000 h L80/B10	460	95	50	7517 1810	285.00
		3000	4900 / 3300	39 / 25	50,000 h L80/B10	460	95	50	7517 1658	330.00
		4000	5200 / 3600	39 / 25	50,000 h L80/B10	460	95	50	7517 1657	330.00
RKL-Z 4 PC ML (PC / IK 06)	Basic	3000	3200 / 1800	26 / 14	50,000 h L80/B10	460	95	50	7517 1850	86.30
		4000	3400 / 1900	26 / 14	50,000 h L80/B10	460	95	50	7517 1860	86.30
		3000	4900 / 3700	39 / 29	50,000 h L80/B10	460	95	50	7517 1700	118.80
		4000	5200 / 3600	39 / 25	50,000 h L80/B10	460	95	50	7517 1710	118.80

RKL-Z 6 with Multilumen function

Type	Version	Colour temp. (K)	Luminous flux (Lm)	System power (W)	LED lifetime	Ø	H	PU	Article No.	Gross €/pcs.
RKL-Z 6 ML (PMMA / IK 02)	Basic	3000	10,400 / 8200	80 / 63	50,000 h L80/B10	580	110	28	7517 5000	189.50
		4000	10,900 / 8700	80 / 63	50,000 h L80/B10	580	110	28	7517 5010	189.50
	HF sensor (Master/Slave)	3000	10,400 / 8200	80 / 63	50,000 h L80/B10	580	110	28	7517 5020	237.50
		4000	10,900 / 8700	80 / 63	50,000 h L80/B10	580	110	28	7517 5030	237.50
	3h emergency lighting	3000	10,400 / 8200	80 / 63	50,000 h L80/B10	580	110	28	7517 5060	417.50
		4000	10,900 / 8700	80 / 63	50,000 h L80/B10	580	110	28	7517 5070	417.50

RKL-Z with DALI dimmable

Type	Version	Colour temp. (K)	Luminous flux (Lm)	System power (W)	LED lifetime	Ø	H	PU	Article No.	Gross €/pcs.
RKL-Z 2 (PMMA / IK 02)	DALI	3000	2400	20	50,000 h L80/B10	300	85	175	7515 1502	106.00
		4000	2500	20	50,000 h L80/B10	300	85	175	7515 1504	106.00
RKL-Z 3 (PMMA / IK 02)	DALI	3000	2900	24	50,000 h L80/B10	370	85	100	7516 1528	127.50
		4000	3100	24	50,000 h L80/B10	370	85	100	7516 1529	127.50
RKL-Z 4 (PMMA / IK 02)	DALI	3000	3200	26	50,000 h L80/B10	460	95	50	7517 1840	136.00
		4000	3400	26	50,000 h L80/B10	460	95	50	7517 1845	136.00
		3000	4500	37	50,000 h L80/B10	460	95	50	7517 1629	162.50
		4000	4800	37	50,000 h L80/B10	460	95	50	7517 1652	162.50
RKL-Z 6 (PMMA / IK 02)	DALI	3000	10,400	80	50,000 h L80/B10	580	110	28	7517 5040	280.00
		4000	10,900	80	50,000 h L80/B10	580	110	28	7517 5050	280.00

• available ex stock | For suitable replacement diffusers see page 112











RKL-Z online:
www.fluolite.de/produkte/serie/rkl-z



Protected against water and dirt.

Compact surface-mounted luminaire with high protection grade (IP 65), suitable for installation in humid environments.

White luminaire housing made of polycarbonate (PC) with pressure compensation plug and two cable entries. Domed diffuser made of textured acrylic (PMMA), translucent opal. Secure and sturdy diffuser attachment thanks to internal closure device. Approved for use indoors or in covered outdoor areas.

-  **High protection grade: IP 65**
-  **Sustainable product thanks to replaceable LED module**
-  **Luminous efficacy up to 125 Lm/W (eligible for funding)**
-  **Diffuser optionally available in UV-resistant PMMA or high-impact PC to IK 06**
-  Long LED lifetime – 50,000 h for L80/B10
-  Colour tolerance (initial MacAdam) 3
-  Versions with DALI or 3-hour emergency lighting available
-  Also available with flat cylindrical diffuser on request

Type	Version	Colour temp. (K)	Luminous flux (Lm)	System power (W)	LED lifetime	Ø	H	PU	Article No.	Gross €/pcs.
RKL-Aqua 2 (PMMA / IK 02)	Basic	3000	1400	12	50,000 h L80/B10	300	115	165	7518 1705 •	83.50
		4000	1500	12	50,000 h L80/B10	300	115	165	7518 1710 •	83.50
	HF sensor (Master/Slave)	3000	1400	12	50,000 h L80/B10	300	115	165	7518 1715 •	124.30
		4000	1500	12	50,000 h L80/B10	300	115	165	7518 1720 •	124.30
RKL-Aqua 2 (PC / IK 06)	Basic	3000	1400	12	50,000 h L80/B10	300	115	165	7518 1730	88.80
		4000	1500	12	50,000 h L80/B10	300	115	165	7518 1740	88.80
RKL-Aqua 3 (PMMA / IK 02)	Basic	3000	1400	12	50,000 h L80/B10	375	135	100	7519 1705 •	99.70
		4000	1500	12	50,000 h L80/B10	375	135	100	7519 1710 •	99.70
	HF sensor (Master/Slave)	3000	1400	12	50,000 h L80/B10	375	135	100	7519 1707	148.80
		4000	1500	12	50,000 h L80/B10	375	135	100	7519 1708	148.80
RKL-Aqua 3 (PC / IK 06)	Basic	3000	1400	12	50,000 h L80/B10	375	135	100	7519 1940	114.00
		4000	1500	12	50,000 h L80/B10	375	135	100	7519 1941	114.00

• available ex stock

Type	Version	Colour temp. (K)	Luminous flux (Lm)	System power (W)	LED lifetime	Ø	H	PU	Article No.	Gross €/pcs.
RKL-Aqua 4 (PMMA / IK 02)	Basic	3000	2100	18	50,000 h L80/B10	475	160	45	7520 1805 •	105.70
		4000	2200	18	50,000 h L80/B10	475	160	45	7520 1810 •	105.70
		3000	3500	30	50,000 h L80/B10	475	160	45	7520 1905	129.50
		4000	3700	30	50,000 h L80/B10	475	160	45	7520 1930 •	129.50
	HF sensor (Master/Slave)	3000	2100	18	50,000 h L80/B10	475	160	45	7520 1815 •	148.80
		4000	2200	18	50,000 h L80/B10	475	160	45	7520 1820 •	148.80
		3000	3500	30	50,000 h L80/B10	475	160	45	7520 1931	165.40
		4000	3700	30	50,000 h L80/B10	475	160	45	7520 1932 •	165.40
RKL-Aqua 4 (PC / IK 06)	Basic	3000	2100	18	50,000 h L80/B10	475	160	45	7520 1708	113.80
		4000	2200	18	50,000 h L80/B10	475	160	45	7520 1710	113.80
		3000	3500	30	50,000 h L80/B10	475	160	45	7520 1940	139.50
		4000	3700	30	50,000 h L80/B10	475	160	45	7520 1715	139.50

• available ex stock

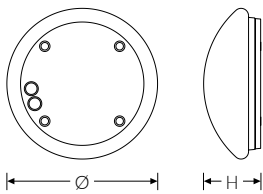

Accessories

Material: metal, available in white and silver-grey. Compatible with Weiler/-Z FL + RKL/-Z + RKL-Aqua.

Deco-ring Colour: white	Outer Ø	Article No.	Gross €/pcs.
	RKL 2	330 3605 5225 •	29.50
	RKL 3	435 3605 5235 •	53.50
	RKL 4	540 3605 5245 •	60.00
	RKL 6	650 3605 5255	89.00

• available ex stock

Deco-ring Colour: silver-grey	Outer Ø	Article No.	Gross €/pcs.
	RKL 2	330 3605 5228 •	29.50
	RKL 3	435 3605 5238 •	53.50
	RKL 4	540 3605 5248 •	60.00
	RKL 6	650 3605 5258	89.00

• available ex stock



RKL-Aqua online:
www.fluolite.de/produkte/serie/rkl-aqua

All RKL luminaires at a glance!

Table showing available RKL luminaire types and versions



	RKL 2 ML		RKL 3 ML		RKL 4 ML			
Colour temperature (Kelvin)	3000 K	4000 K	3000 K	4000 K	3000 K		4000 K	
Luminous flux (lumens)	2400/1000 Lm	2500/1100 Lm	2900/1500 Lm	3100/1700 Lm	3200/1800 Lm	≥ 4900/3300 Lm	3400/1900 Lm	≥ 5200/3600 Lm
System power (watts)	20/9 W	20/9 W	24/12 W	24/12 W	26/14 W	≥ 39/25 W	26/14 W	≥ 39/25 W
Basic (On/Off)	7510 1800 € 61.00	7510 1805 € 61.00	7511 1714 € 72.30	7511 1717 € 72.30	7512 1700 € 80.00	7512 4263 € 113.60	7512 1710 € 80.00	7512 4261 € 113.60
HF sensor (Master/Slave capable)	7510 1820 € 115.50	7510 1825 € 115.50	7511 1630 € 124.30	7511 1631 € 124.30	7512 1740 € 120.80	7512 4279 € 146.30	7512 1750 € 120.80	7512 4277 € 146.30
Emergency lighting (Basic: 3 hours)			7511 1627 € 290.00	7511 1628 € 290.00	7512 1760 € 285.00	7512 4283 € 321.80	7512 1770 € 285.00	7512 4281 € 321.80
DALI (dimmable)	7510 1730 € 106.00	7510 1735 € 106.00	7511 1609 € 127.50	7511 1610 € 127.50	7512 1800 € 132.50	7512 4275 € 145.00	7512 1810 € 132.50	7512 4272 € 145.00
PC diffuser (Basic On/Off)	7510 1850 € 66.30	7510 1855 € 66.30	7511 1721 € 79.80	7511 1722 € 79.80	7512 1720 € 82.00	7512 4269 € 118.60	7512 1730 € 82.00	7512 4266 € 118.60



	RKL-Z 2 ML		RKL-Z 3 ML		RKL-Z 4 ML			
Colour temperature (Kelvin)	3000 K	4000 K	3000 K	4000 K	3000 K		4000 K	
Luminous flux (lumens)	2400/1000 Lm	2500/1100 Lm	2900/1500 Lm	3100/1700 Lm	3200/1800 Lm	≥ 4900/3300 Lm	3400/1900 Lm	≥ 5200/3600 Lm
System power (watts)	20/9 W	20/9 W	24/12 W	24/12 W	26/14 W	≥ 39/25 W	26/14 W	≥ 39/25 W
Basic (On/Off)	7515 1800 € 61.00	7515 1805 € 61.00	7516 1519 € 72.30	7516 1526 € 72.30	7517 1750 € 82.00	7517 1628 € 110.80	7517 1760 € 82.00	7517 1651 € 110.80
HF sensor (Master/Slave capable)	7515 1820 € 115.50	7515 1825 € 115.50	7516 1531 € 124.30	7516 1532 € 124.30	7517 1770 € 130.50	7517 1656 € 157.50	7517 1780 € 130.50	7517 1653 € 157.50
Emergency lighting (Basic: 3 hours)			7516 1608 € 290.00	7516 1609 € 290.00	7517 1800 € 285.00	7517 1658 € 330.00	7517 1810 € 285.00	7517 1657 € 330.00
DALI (dimmable)	7515 1502 € 106.00	7515 1504 € 106.00	7516 1528 € 127.50	7516 1529 € 127.50	7517 1840 € 136.00	7517 1629 € 162.50	7517 1845 € 136.00	7517 1652 € 162.50
PC diffuser (Basic On/Off)	7515 1850 € 66.30	7515 1855 € 66.30	7516 1552 € 79.80	7516 1556 € 79.80	7517 1850 € 86.30	7517 1700 € 118.80	7517 1860 € 86.30	7517 1710 € 118.80



RKL 6 ML		RKL 6			
3000 K	4000 K	3000 K		4000 K	
10,400/8200 Lm	10,900/8700 Lm	≥ 3400 Lm	5100 Lm	≥ 3600 Lm	≥ 5200 Lm
80/63 W	80/63 W	30 W	≥ 45 W	30 W	≥ 45 W
7513 1800 € 170.30	7513 1810 € 170.30	7513 1642 € 142.80	7513 1687 € 151.90	7513 1652 € 142.80	7513 1671 € 151.90
7513 1840 € 196.80	7513 1850 € 196.80	7513 1645 € 190.50	7513 1688 € 193.50	7513 1646 € 190.50	7513 1680 € 193.50
7513 1820 € 391.80	7513 1830 € 391.80		7513 1686 € 391.80		7513 1685 € 391.80
7513 1860 € 239.00	7513 1870 € 239.00		7513 1689 € 200.00		7513 1676 € 200.00
			7513 1720 € 157.30		7513 1725 € 157.30



RKL-Z 6 ML		RKL Aqua 2		RKL Aqua 3		RKL Aqua 4			
3000 K	4000 K	3000 K	4000 K	3000 K	4000 K	3000 K		4000 K	
10,400/8200 Lm	10,900/8700 Lm	1400 Lm	1500 Lm	1400 Lm	1500 Lm	2100 Lm	3500 Lm	2200 Lm	3700 Lm
80/63 W	80/63 W	12 W	12 W	12 W	12 W	18 W	30 W	18 W	30 W
7517 5000 € 189.50	7517 5010 € 189.50	7518 1705 € 83.50	7518 1710 € 83.50	7519 1705 € 99.70	7519 1710 € 99.70	7520 1805 € 105.70	7520 1905 € 129.50	7520 1810 € 105.70	7520 1930 € 129.50
7517 5020 € 237.50	7517 5030 € 237.50	7518 1715 € 124.30	7518 1720 € 124.30	7519 1707 € 148.80	7519 1708 € 148.80	7520 1815 € 148.80	7520 1931 € 165.40	7520 1820 € 148.80	7520 1932 € 165.40
7517 5060 € 417.50	7517 5070 € 417.50								
7517 5040 € 280.00	7517 5050 € 280.00								
		7518 1730 € 88.80	7518 1740 € 88.80	7519 1940 € 114.00	7519 1941 € 114.00	7520 1708 € 113.80	7520 1940 € 139.50	7520 1710 € 113.80	7520 1715 € 139.50

Quadro-Lite

LED WALL AND CEILING LUMINAIRE

CE IK02 IP65



Compact universal surface-mounted luminaire with high protection grade (IP 65), suitable for installation in humid environments.

White luminaire housing made of polycarbonate (PC), flame retardant. Opal PMMA diffuser. Attractive design for use indoors or in covered outdoor areas.

- ☛ High protection grade: IP 65
- ☛ Versions available as a house-number light with twilight switch
- ☛ Sustainable product thanks to replaceable LED module
- ☛ AC/DC capable

- ☛ Luminous efficacy up to 122 Lm/W **(eligible for funding)**
- ☛ Long LED lifetime – up to 50,000 h for L90/B10
- ☛ Colour tolerance (initial MacAdam) 3
- ☛ Ambient temperature from –30°C to +35°C
- ☛ Non-ageing rubber profile (EPDM)

Type		Colour temp. (K)	Luminous flux (Lm)	System power (W)	LED lifetime	L	W	H	PU	Article No.	Gross €/pcs.
Quadro-Lite	1 x 6	3000	500	7	50,000 h L70/B50	200	200	60	375	6581 4810 •	55.00
		4000	500	6	50,000h L70/B50	200	200	60	375	6581 4812 •	55.00
	1 x 12	3000	1100	9	50,000 h L90/B10	300	300	90	375	6581 5110 •	115.00
		4000	1100	9	50,000h L90/B10	300	300	90	375	6581 5112 •	115.00

House-number light with integrated twilight switch (TS)

Quadro-Lite 200 HSL	1 x 6	4000	500	6	50,000h L70/B50	200	200	60	375	6581 4850 •	83.50
---------------------	-------	------	-----	---	-----------------	-----	-----	----	-----	-------------	-------

(Numbers are not included in the scope of delivery and must be ordered separately: article No. 2899 0450)

- available ex stock

NEW Insect-friendly house-number light with integrated twilight switch (TS)

Particularly insect-friendly thanks to the light colour of 2700 K. This value is outside the visible range for insects, which means they won't be attracted to this additional light source. It actively protects insects without neglecting the benefits for humans.

Quadro-Lite 200 HSL, Multilumen	2700	600 / 100	6 / 1	50,000h L90/B10	200	200	60	375	6581 4900	109.00
---------------------------------	------	-----------	-------	-----------------	-----	-----	----	-----	-----------	--------

(With enclosed number set)

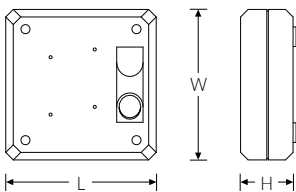

LED positions:

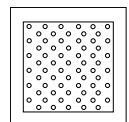

1 x 6 / 1 x 12

Accessories

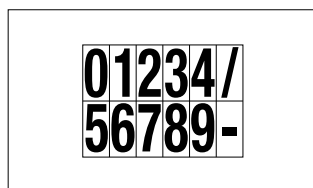

Type	Article No.	Gross €/pcs.
Number set 0–9, including forward slash and hyphen for house-number light Quadro-Lite LED with twilight switch, made of black, self-adhesive, weatherproof PVC film.	2899 0450	2.70



Rondo-Lite

LED WALL AND CEILING LUMINAIRE



Compact universal surface-mounted luminaire with high protection grade (IP 65), suitable for installation in humid environments.

White luminaire housing made of polycarbonate (PC), flame retardant. Opal PMMA diffuser. Attractive design for use indoors or in covered outdoor areas.

- ☛ High protection grade: IP 65
- ☛ Sustainable product thanks to replaceable LED module
- ☛ Shock resistant Ø 260 mm, IK 06
- ☛ AC/DC capable

- ☛ Long LED lifetime – up to 70,000 h for L80/B10
- ☛ Colour tolerance (initial MacAdam) 3
- ☛ Ambient temperature from -20°C to +25°C
- ☛ Non-ageing rubber profile (EPDM)

Type	Version			Colour temp. (K)	Luminous flux (Lm)	System power (W)	LED lifetime	Ø	H	PU	Article No.	Gross €/pcs.
Rondo-Lite	Basic	2 x 4.5	IK06	3000	800	10	70,000 h L80/B10	260	60	100	6585 4810	76.30
				4000	850	10	70,000h L80/B10	260	60	100	6585 4812 •	76.30
		1 x 12	IK03	3000	950	11	50,000 h L70/B10	360	90	100	6585 5110	100.00
				4000	950	11	50,000 h L70/B10	360	90	100	6585 5112	100.00

• available ex stock

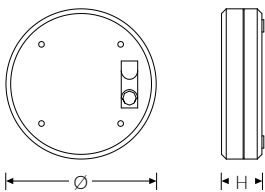

LED positions:

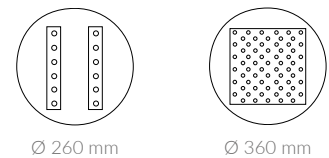





Lay-in luminaires Panel luminaires



Modul Four EL 64



Modul Four 65



Flat-A ML 66 – 67



FLAT-A 68



FLAT-E 69

High-quality and efficient LED luminaires enable a perfect lighting solution for modern working environments. They are characterised by a high quality of light that promotes health, well-being and productivity.

Modul Four EL

LED LAY-IN LUMINAIRE

CE IK02 IP20 UGR < 16

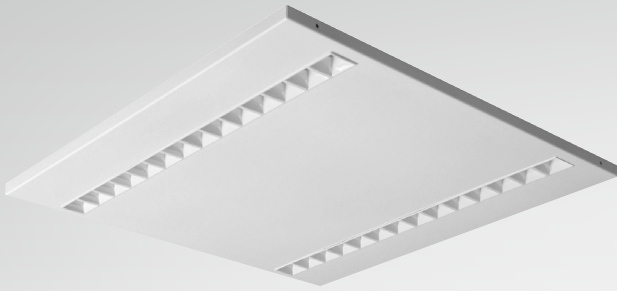

Modern lens technology.

The ideal alternative to LED panel luminaires. Easy-to-install lay-in luminaire with visible lens optics for modular ceiling systems with visible trunking (module 625). Metal housing, white. Can also be used as a surface-mounted luminaire with accessories.

Economical and energy-efficient lighting solution for office applications with challenging requirements in terms of glare limitation.

Unified Glare Rating (UGR) < 16

Luminous efficacy up to 157 Lm/W **(eligible for funding)**

Sustainable product thanks to replaceable LED module / converter

LED lifetime L80/80,000 h

Colour tolerance (initial MacAdam) 3

Versions with DALI available

Type	Module	Version	Colour temp. (K)	Luminous flux (Lm)	System power (W)	LED lifetime	L	W	H	Article No.	Gross €/pcs.
Modul Four EL 2/L	625 x 625	Basic	4000	4400	28	80,000h L80/B50	622	622	25	8717 1000	165.00
		DALI	4000	6100	42	80,000 h L80/B50	622	622	25	8717 1015	245.00
Modul Four EL 4/4	625 x 625	Basic	4000	3900	27	80,000h L80/B50	622	622	25	8717 1010	170.00
Modul Four EL 1/L	1250 x 312	Basic	4000	4400	28	80,000h L80/B50	1245	310	25	8717 1005	170.00
		DALI	4000	6100	42	80,000h L80/B50	1245	310	25	8717 1020	237.50



Modul Four EL 2/L, module 625

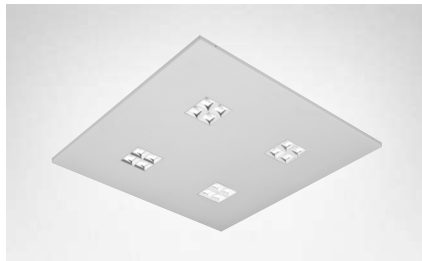

Modul Four EL 4/4, module 625



Modul Four EL 1/L, module 1250 x 312

Accessories / Installation components

Compatible with Modul Four EL and Modul Four.



Aluminium mounting frame, white



Aluminium installation frame, white

Type	Article No.	Gross €/pcs.
Mounting frame for module 625, height 48 mm	3597 5320	82.00
Mounting frame for module 1250 x 312, height 48 mm	3597 5340	97.00
Installation frame for module 625	3597 5300	65.00
Installation frame for module 1250 x 312	3597 5310	77.00



Modul Four

LED LAY-IN LUMINAIRE

CE IK03 IP20 UGR < 16



Attractive design meets high-quality workmanship

High quality standards

Lighting solution for additional flexibility in the office

Very long LED lifetime: L90/50,000 h

High-grade lens technology.

High-quality LED lay-in luminaire with visible lens optics. Sheet steel housing in RAL 9016 for installation in modular ceiling systems with visible trunking (module 625). Can also be used as a surface-mounted or suspended luminaire with suitable accessories. Efficient solution with high luminous efficacy and a very good Unified Glare Rating for high-quality lighting solutions in offices and educational facilities.

- Unified Glare Rating UGR < 19 or UGR < 16**
- Luminous efficacy 130 Lm/W** (eligible for funding)
- DALI dimmable**
- Long LED lifetime – up to 50,000 h for L90/B10
- Colour tolerance (initial MacAdam) 3
- Ambient temperature from +5°C to +35°C
- Includes standard and Linect® quick connection system
- Various designs and module arrangements optionally possible

Type	Module	Version	Colour temp. (K)	Luminous flux (Lm)	System power (W)	LED lifetime	L	W	H	Article No.	Gross €/pcs.
Modul Four 2/4L	625 x 625	DALI	4000	5600	43	50,000h L90/B10	621	621	27	8803 5000	383.20
Modul Four 1/8L	1250 x 312	DALI	4000	5600	43	50,000h L90/B10	1246	308	27	8803 5300	382.80



Modul Four 2/4L, module 625



Modul Four EL 1/8L, module 1250 x 312

Optionally available:

- High glare reduction with UGR < 16 (< 5,000 lumens), especially suitable as lighting for technical-drawing offices
- Version with 3h emergency lighting
- With 3000 K, Tunable White and colour rendering index Ra > 90
- Possibility to integrate sensors
- Module arrangement in accordance with customer requirements

Maximum flexibility in terms of luminaire design.

Examples of possible arrangements and/or orientations of the LED modules as well as the surface colour (black or white).



Modul Four online:
www.fluolite.de/produkte/serie/modulfour

Flat-A ML Highlights

Technical variants



Multilumen
Adjustable light output



DALI
With dimming function

Sustainability across the board



Sustainable
thanks to energy-efficient
LED technology and individu-
ally replaceable accessories.



5-year Fluolite warranty
for luminaires with
a lifetime of
≥ 50,000 operating hours.

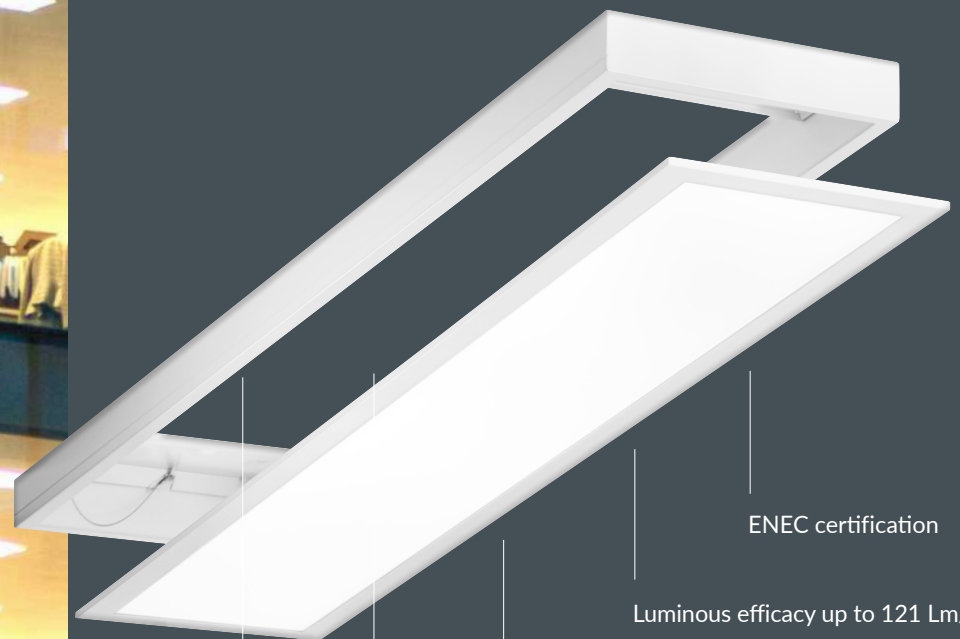

ENECE certification

Luminous efficacy up to 121 Lm/W

Unified Glare Rating for VDU
and office workplaces: UGR <19

Flexible cable feed at the rear

Luminaire insert on long side



Scan the code and watch our
product video on YouTube.

Flat-A ML



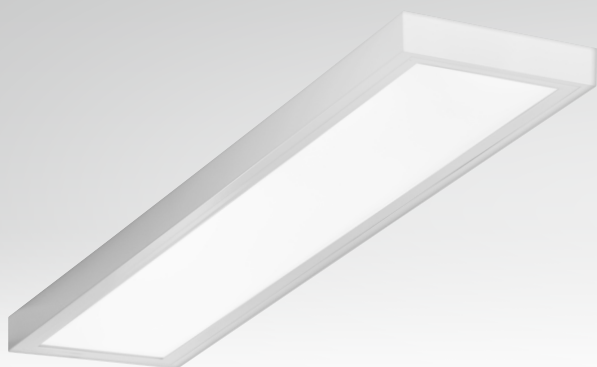

LED PANEL SURFACE-MOUNTED LUMINAIRE









CE    IK06 IP40 UGR < 19



Efficient LED panel surface-mounted luminaire. Multilumen technology for adjustable light output (min/max), pre-set to maximum output upon delivery. Steel-frame housing, white. Luminaire insert on long side. Microprismatic cover. Protection grade IP 40 on room side, IP 20 on ceiling side.

The professional lighting solution for new buildings as well as refurbishment and conversion projects.

-  **ENEC certification**
-  **Multilumen function**
-  **Sustainable product thanks to individually replaceable accessories**
-  **Includes frame for surface mounting with perfect mitre joint**
-  **Unified Glare Rating (UGR) < 19**

-  Luminous efficacy up to 121 Lm/W
-  Long LED lifetime – 50,000 h for L80/B10
-  Colour tolerance (initial MacAdam) 3
-  AC/DC capable
-  Uniform light distribution
-  Ambient temperature from –20°C to +40°C
-  Luminaire insert on long side
-  Flexible cable feed at the rear

Flat-A with Multilumen function

Type	Colour temp. (K)	Luminous flux (Lm)	System power (W)	LED lifetime	L	W	PU	Article No.	Gross €/pcs.
Flat-A ML MP 1500 x 300	4000	6000 / 4000	53 / 33	50,000 h L80/B10	1500	315	30	8811 0200 •	249.50

• available ex stock

Flat-A with DALI dimmable

Type	Colour temp. (K)	Luminous flux (Lm)	System power (W)	LED lifetime	L	W	PU	Article No.	Gross €/pcs.
Flat-A MP 1500 x 300 DALI	4000	6000	53	50,000 h L80/B10	1500	315	30	8811 0210	274.10

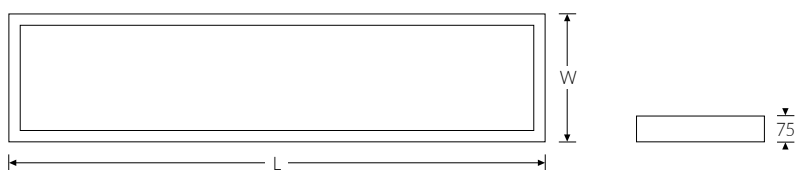

Accessories / Replacement parts



Steel frame for surface mounting, white



Lay-in luminaire, 1500 x 300

Type	Article No.	Gross €/pcs.
Frame for surface mounting for lay-in luminaire, 1500 x 300	3597 5560 •	95.00
Lay-in luminaire, 1500 x 300 (without converter)	8809 0070	180.00
Converter for FLAT-A ML	3001 0482 •	56.30

• available ex stock



Flat-A ML online:
www.fluolite.de/produkte/serie/flat-a

Flat-A

LED PANEL SURFACE-MOUNTED LUMINAIRE

CE  IK06 IP40 UGR < 19



Premium surface-mounted panel luminaire.

Highly efficient LED panel surface-mounted luminaire. Steel-frame housing, height 48.5 mm, white. Optionally available with opal or microprismatic cover. Protection grade IP 40 (room side). Ideal for offices and business premises. Prismatic cover suitable for VDU workstations.

- ☛ Includes frame for surface mounting with perfect mitre joint
- ☛ Homogeneous illumination of the optics
- ☛ Luminous efficacy up to 124 Lm/W (eligible for funding)
- ☛ Very long LED lifetime: 70,000 h for L80/B10

- ☛ Easy to install thanks to the integrated frame for surface mounting
- ☛ Colour tolerance (initial MacAdam) 3
- ☛ Ambient temperature from +10°C to +40°C
- ☛ Unified Glare Rating
UGR < 19 with microprismatic cover
UGR < 22 with opal cover

Type	Module	Colour temp. (K)	Luminous flux (Lm)	System power (W)	LED lifetime	L	W	PU	Article No.	Gross €/pcs.
Flat-A Opal	625 x 625	3000	3400	29	70,000h L80/B10	620	620	50	8811 0040	210.00
		4000	3600	29	70,000h L80/B10	620	620	50	8811 0050	210.00
	1200 x 300	3000	3400	29	70,000 h L80/B10	1220	320	50	8811 0080	240.00
		4000	3600	29	70,000 h L80/B10	1220	320	50	8811 0090	240.00
Flat-A Microprismatic	625 x 625	3000	3200	29	70,000h L80/B10	620	620	50	8811 0060	220.00
		4000	3400	29	70,000 h L80/B10	620	620	50	8811 0070	220.00
	1200 x 300	3000	3200	29	70,000h L80/B10	1220	320	50	8811 0100	230.00
		4000	3400	29	70,000 h L80/B10	1220	320	50	8811 0110	230.00

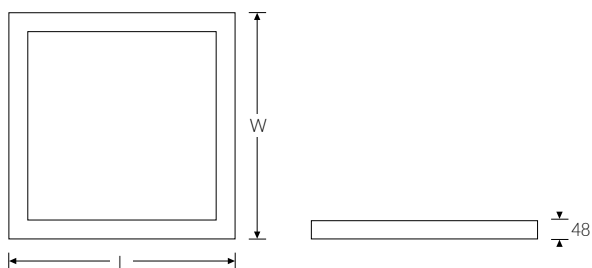

Flat-A, rear



Frame with invisible mitre joint



Flat-A, module 1200 x 300



Flat-E

LED PANEL LAY-IN / SUSPENDED LUMINAIRE

CE IK06 IP20 IP40 UGR < 19



Premium lay-in panel luminaire.

Can be used as a lay-in or suspended luminaire (see accessories for suspension). Steel-frame housing, height 14 mm (plus gear), white. Optionally available with opal or microprismatic cover. Protection grade IP 40 on room side, IP 20 on ceiling side. Particularly suitable for installation in coffered ceilings and therefore ideal for offices and commercial premises.

- ☛ **Ultra-flat design**
- ☛ **Homogeneous illumination of the opal cover**
- ☛ **Microprismatic cover suitable for VDU workstations**
- ☛ **Very long LED lifetime: 70,000 h for L80/B10**

- ☛ Can also be used as a suspended luminaire
- ☛ Colour tolerance (initial MacAdam) 3
- ☛ Ambient temperature from +10°C to +40°C
- ☛ Unified Glare Rating
 - UGR < 19 with microprismatic cover
 - UGR < 22 with opal cover
- ☛ Optionally available with DALI

Type	Module	Colour temp. (K)	Luminous flux (Lm)	System power (W)	LED lifetime	L	W	PU	Article No.	Gross €/pcs.
Flat-E Opal	625 x 625	3000	3400	29	70,000 h L80/B10	621	621	50	8809 0090 •	111.00
		4000	3600	29	70,000 h L80/B10	621	621	50	8809 0080 •	111.00
	1200 x 300	3000	3400	29	70,000 h L80/B10	1196	296	50	8809 0060	142.50
		4000	3600	29	70,000 h L80/B10	1196	296	50	8809 0050	142.50
Flat-E Microprismatic	625 x 625	3000	3200	29	70,000h L80/B10	621	621	50	8809 0195 •	125.00
		4000	3400	29	70,000 h L80/B10	621	621	50	8809 0185 •	125.00
	1200 x 300	3000	3200	29	70,000 h L80/B10	1196	296	50	8809 0165	147.00
		4000	3500	29	70,000 h L80/B10	1196	296	50	8809 0155	147.00

• available ex stock

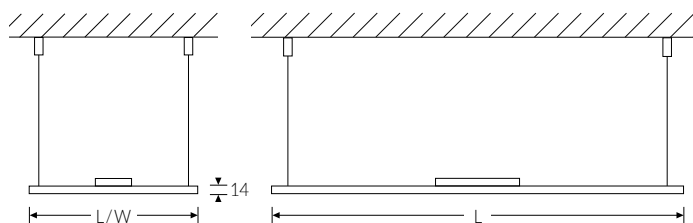

Optionally available:

- ☛ Tunable White
- ☛ Daylight-dependent control
- ☛ Protection grade IP 65
- ☛ Busbar adapter
- ☛ Logo as per customer requirements

Accessories / Installation components



Type	Article No.	Gross €/pcs.
Cable suspension Flat-E LED set* (4-point)	3596 2800 •	46.30

* Set consisting of 4 freely adjustable suspension cables (max. length 3 m) and the matching ceiling fixings.



Flat-E online:
www.fluolite.de/produkte/serie/flat-e





Downlights



ARO

72





Bodman FL

73

LED downlights provide optimal ambient lighting in areas such as shops, corridors, surgeries, meeting rooms, hotels and foyers. Their compact design guarantees quick and easy installation.







-  **Switchable colour temperature**
3000 K, 4000 K, 5700 K
-  **Wide light distribution**
-  **Flat design, shallow ceiling void**

Switchable colour temperature.

LED recessed downlight in three different sizes and power ratings. The colour temperature can be changed by means of a switch on the luminaire. Depending on the area and application, you can choose between warm white, neutral white and daylight white before installation. Major advantage – only one luminaire type is required for different lighting moods.

Die-cast aluminium housing. Room side IP 54 (with closed ceiling). External LED driver is included.

-  Dimmable with phase-cut dimmer
-  Ambient temperature from -20°C to +45°C
-  Protection class II
-  Instant start
-  Optionally available with DALI

Type	Colour temp. (K)	Luminous flux (Lm)	System power (W)	LED lifetime	Ø	H	E Ø	Article No.	Gross €/pcs.
ARO-13WWSCW1	3000	1756	13	45,000 h L80/B20	145	45	120	6608 5000	71.00
	4000								
	5700								
ARO-15WWSCW1	3000	2026	15	45,000h L80/B20	190	45	160	6608 5010	84.80
	4000								
	5700								
ARO-22WWSCW1	3000	2971	22	45,000h L80/B20	228	45	200	6608 5040	107.40
	4000								
	5700								

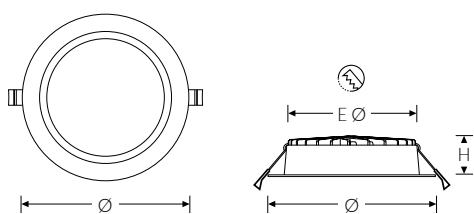

E Ø = wall or ceiling cut-out

Adaptable due to variable colour temperature.

The colour temperature can be changed via a switch on the rear of the luminaire. Depending on the area and application, you can choose between warm white, neutral white and daylight white.

Major advantage – only one luminaire type is required for different lighting moods and applications.

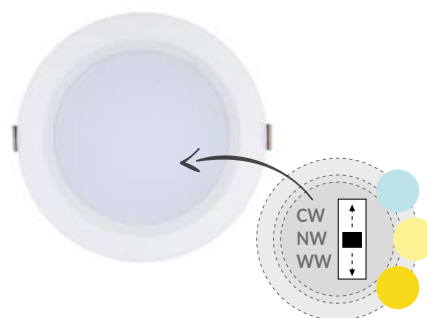

Accessories

Matt steel compensating ring for oversized ceiling cut-outs.

Type	Article No.	Gross €/pcs.
DL compensating ring, outer Ø 195 mm, for ARO 15 W	3597 5150	22.50
DL compensating ring, outer Ø 240 mm, for ARO 15 W	3597 5160	26.25



NEW Bodman FL

LED DOWNLIGHT

CE □ IK07 IP20 IP40 UGR < 19



Round LED downlight consisting of a white aluminium housing with matt aluminium reflector for installation in sawn ceiling openings.

Tool-free installation thanks to spring clips. Simple connection / loop-through thanks to cable connection box. Protection grade IP 40 on room side, IP 20 on ceiling side.

Suitable for use in offices and sales rooms, corridors, as well as meeting rooms and event spaces.

- ☛ **Multilumen function**
- ☛ **Unified Glare Rating (UGR) < 19**
- ☛ **Cable connection box (for 2 cables)**
- ☛ **Luminous efficacy up to 133 Lm/W** (eligible for funding)

- ☛ Colour tolerance (initial MacAdam) 3
- ☛ Ambient temperature from -10°C to +40°C
- ☛ Protection class II

Bodman FL with Multilumen function

Type	Version	Colour temp. (K)	Luminous flux (Lm)	System power (W)	LED lifetime	Ø	H	E Ø	Article No.	Gross €/pcs.
Bodman FL 150 ML	Basic	4000	1500 / 800	12 / 6	60,000 h L80/B10	185	75	160	7397 2000 •	69.10
Bodman FL 200 ML	Basic	4000	2400 / 800	19 / 6	60,000 h L80/B10	236	90	210	7397 2040 •	79.20

• available ex stock

Bodman FL with DALI dimmable

Type	Version	Colour temp. (K)	Luminous flux (Lm)	System power (W)	LED lifetime	Ø	H	E Ø	Article No.	Gross €/pcs.
Bodman FL 150	DALI	4000	1500	12	60,000 h L80/B10	185	75	160	7397 2010	109.90
Bodman FL 200	DALI	4000	2400	19	60,000 h L80/B10	236	90	210	7397 2050	118.50

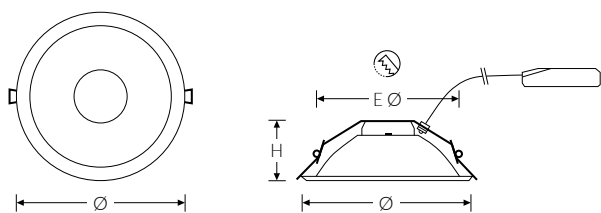

E Ø = wall or ceiling cut-out



Bodman FL online:
www.fluolite.de/produkte/unterkategorie/downlights





Trunking systems and batten



TRX 76 - 78



TRX Lens 79



TRA 80 - 85



TRA click & connect 86 - 87



Minilite 89

Trunking systems are versatile lighting solutions that are perfect for logistics halls and warehouses, assembly and production facilities as well as wholesale and retail outlets.

Our TRX trunking not only impresses due to its sophisticated rapid installation system that has proven itself over many years, but also thanks to its highly efficient LED light inserts with lens technology.

The Fluolite TRA trunking system is easy to use and can be customised with a variety of our light inserts and luminaires – up to IP 65 trunking. Our service team will be happy to advise you!

Easy.
Faster.
Tool-free.

RAPID INSTALLATION SYSTEM FOR TRUNKING



Lighting installations must be economical, cost-effective and state of the art.

During its development, particular emphasis was placed on tool-free installation that can be completed in a very short time.



- 1 Choice of mounting: ceiling mounting or suspension with chain or rope.
- 2 Clip the rail into the hanger (max. fixing span 3 m).
- 3 The electrical connection to the starter element is established without tools, the trunking can then be installed while under voltage.
- 4 Push the middle/end element of the trunking into the end of the starter element and lock it. This creates the electrical and mechanical connection.
- 5 The light unit and the electrical contact are specified.
- 6 The TRX LED light unit is secured in position by clipping it into the rail.



The TRX trunking system can be installed quickly and easy without tools. This saves you time and thus ensures economical installation. The through-wiring is permanently integrated in the trunking.

The rapid installation system for TRX trunking is a universal lighting solution for warehouses, high-bay warehouses, production areas and workshops.

TRX trunking

The TRX trunking system is housingd on a trunking rail made of profiled steel that is painted white on the outside and is available in three lengths. The trunking is equipped with 5 x 2.5 mm² or 7 x 2.5 mm² through-wiring as standard. The individual rails can be mounted very quickly and easily without tools thanks to the integrated connecting elements.



Trunking starter element



Trunking middle /end element

TRX trunking starter elements

Type	Description	L	PU	Article No.	Gross €/pcs.
TRX-A 58/1	5-pin, TW 5 x 2.5 mm ²	1530	2/140	7414 0010	• 54.40
	7-pin, TW 7 x 2.5 mm ²	1530	2/140	7414 0012	• 73.50
TRX-A 58/2	5-pin, TW 5 x 2.5 mm ²	3060	2/140	7414 0020	• 75.20
	7-pin, TW 7 x 2.5 mm ²	3060	2/140	7414 0022	• 93.80
TRX-A 58/3	5-pin, TW 5 x 2.5 mm ²	4590	2/140	7414 0030	• 97.20
	7-pin, TW 7 x 2.5 mm ²	4590	2/140	7414 0032	• 124.80

TRX trunking middle/end elements

Type	Description	L	PU	Article No.	Gross €/pcs.
TRX-ME 58/2	5-pin, TW 5 x 2.5 mm ²	3060	2/140	7414 0120	• 74.60
	7-pin, TW 7 x 2.5 mm ²	3060	2/140	7414 0122	• 95.30
TRX-ME 58/3	5-pin, TW 5 x 2.5 mm ²	4590	2/140	7414 0130	• 96.90
	7-pin, TW 7 x 2.5 mm ²	4590	2/140	7414 0132	• 122.50

• available ex stock

Accessories / Installation components

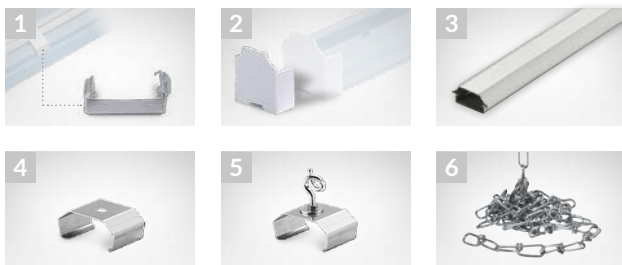

Type	Description	Article No.	Gross €/pcs.
TRX-Ka-Pri	Mini cable rack	1 7414 9024	• 3.30
TRX-Sch-E-LED	Trunking end cap for LED light unit	2 7430 0050	• 3.00
TRX-BA LED	Cover strip 1530 mm	3 7430 0035	• 15.50
TRX-DB	TRX-TRA ceiling fixings	4 7414 9031	• 2.99
TRX-KA	TRX-TRA chain hanger (order 1 per 2.5 m)	5 7414 9030	• 4.75
TRX-Kno-KE	Chain, 1 bundle, 30 m	6 7414 9022	• 40.60

• available ex stock



Two trunking end caps are included with the TRX standard starter elements. However, these cannot be used for the TRX Lens light unit. The special trunking end caps (article No. 7430 0050) must be ordered separately.

Rapid installation system for TRX Lens trunking, length 1.53 metres.

Trunking length (m)	Trunking units					TRX Lens trunking insert	Ceiling fixings	Chain hanger	Trunking end cap
		Starter element 1-length	Starter element 2-length	Starter element 3-length	Middle / End element 3-length				
3.06	2	-	1	-	-	2	2	2	2
4.59	3	-	-	1	-	3	3	3	2
6.12	4	1	-	-	1	4	4	4	2
7.65	5	-	1	-	1	5	4	4	2
9.18	6	-	-	1	1	6	5	5	2
10.71	7	1	-	-	2	7	5	5	2
12.24	8	-	1	-	2	8	6	6	2
13.77	9	-	-	1	2	9	7	7	2
15.30	10	1	-	-	3	10	7	7	2
16.83	11	-	1	-	3	11	8	8	2
18.36	12	-	-	1	3	12	8	8	2
19.89	13	1	-	-	4	13	9	9	2
21.42	14	-	1	-	4	14	10	10	2
22.95	15	-	-	1	4	15	10	10	2
24.48	16	1	-	-	5	16	11	11	2
26.01	17	-	1	-	5	17	12	12	2
27.54	18	-	-	1	5	18	12	12	2
29.07	19	1	-	-	6	19	13	13	2
30.60	20	-	1	-	6	20	13	13	2
32.13	21	-	-	1	6	21	14	14	2
33.66	22	1	-	-	7	22	15	15	2
35.19	23	-	1	-	7	23	15	15	2
36.72	24	-	-	1	7	24	16	16	2
38.25	25	1	-	-	8	25	16	16	2



The “click & connect” capable luminaires (page 84 – 85) can also be adapted for use with the TRX trunking systems using special fasteners.



TRX Lens Plug & Play

LED TRUNKING INSERT



Linear design & the latest lens technology.

The TRX Lens trunking inserts allow quick and easy installation of new lighting projects or simple replacement of existing Fluolite TRX light units.

- Professional lighting solutions for warehouses, production halls and workshops, exhibition areas and shops.
- The Plug & Play system simplifies the installation process and thus considerably reduces the required effort.
- Optimum light control thanks to state-of-the-art lens technology for uniform light distribution.

- Luminous efficacy up to 162 Lm/W (eligible for funding)
- Ambient temperature from -20°C to +35°C
- LED lifetime – 50,000 h for L80/B10
- Colour tolerance (initial MacAdam) 3
- Versions with DALI available

TRX Lens trunking inserts

Consisting of white aluminium profiles. Fits on trunking with a length of 1530 mm.

TRX Lens trunking inserts can be used in 5-pin and 7-pin trunking.

Type	Version	Colour temp. (K)	Luminous flux (Lm)	System power (W)	LED lifetime	PU	Dispersion characteristic	Dispersion angle	Article No.	Gross €/pcs.
TRX Lens	Basic	4000	6000	37	50,000 h L80/B10	2/72	Extensive	90°	7432 0250 *	185.60
							Symmetrical	60°	7432 0350 *	185.60
		4000	9000	59	50,000 h L80/B10	2/72	Extensive	90°	7432 0650 *	185.60
							Symmetrical	60°	7432 0750 *	185.60
		4000	12,000	88	50,000 h L80/B10	2/72	Extensive	90°	7432 0950 *	206.90
							Symmetrical	60°	7432 1050 *	206.90

TRX Lens trunking inserts with DALI can only be used in 7-pin trunking.

TRX Lens	DALI	4000	6000	37	50,000 h L80/B10	2/72	Extensive	90°	7432 0265	212.40
							Symmetrical	60°	7432 0365	212.40
		4000	9000	59	50,000 h L80/B10	2/72	Extensive	90°	7432 0665 *	213.50
							Symmetrical	60°	7432 0765	213.50
		4000	12,000	88	50,000 h L80/B10	2/72	Extensive	90°	7432 0965	224.70
							Symmetrical	60°	7432 1065	224.70

* available ex stock

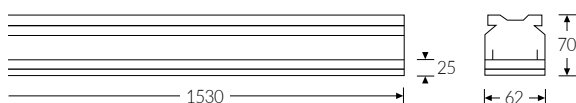

Different optics and perfect light, matched to the respective areas of application:

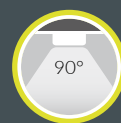

Wide light cone for broad illumination. Suitable for open areas, rooms and halls.

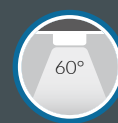

Light cone for deep/wide illumination. Suitable for aisles and high-ceilinged areas.

Other light-distribution angles optionally available:



30° light distribution



Asymmetrical, left



Asymmetrical, right



Asymmetrical on both sides



TRX Lens online:
www.fluolite.de/produkte/serie/trx-lens

Easy. Variable. Individual.
TRA



One trunking system. Many applications.

- ☞ Flexible trunking lengths
- ☞ Inserts can be freely positioned
- ☞ Fast installation
- ☞ Compatible with Fluolite moisture-proof luminaires
- ☞ Variable trunking system for surface mounting or suspended mounting of luminaires on cables or chains
- ☞ The perfect choice for diverse requirements, such as lighting solutions for production, industrial and logistics facilities as well as sales areas

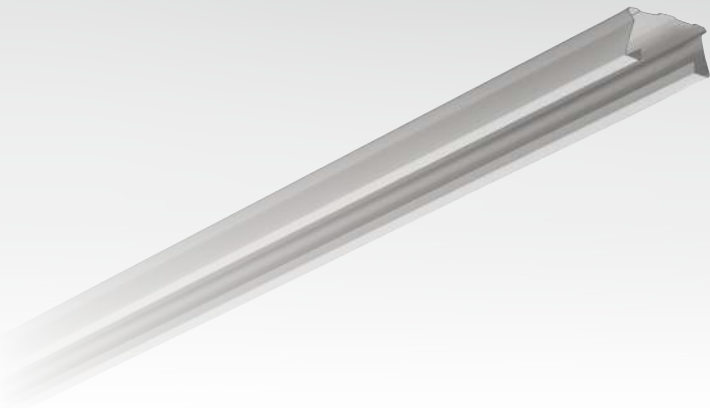

TRA trunking

This trunking is made from a galvanised steel profile, painted white on the outside and available in two lengths. The individual rails can be mounted quickly, easily and without tools using the TRA rail connector.

Freely configurable trunking system with a low overall height. Variable trunking with freely selectable luminaire positions. Customised lighting solutions are possible thanks to quick and easy installation as well as variable cable routing in the wiring channel.

Type	L	W	H	PU	Article No.	Gross €/pcs.
TRA trunking 58/2	1	3065	65	30	60	3609 5025• 28.40
TRA trunking 58/3	2	4595	65	30	60	3609 5040• 41.50

• available ex stock

Accessories / Installation components

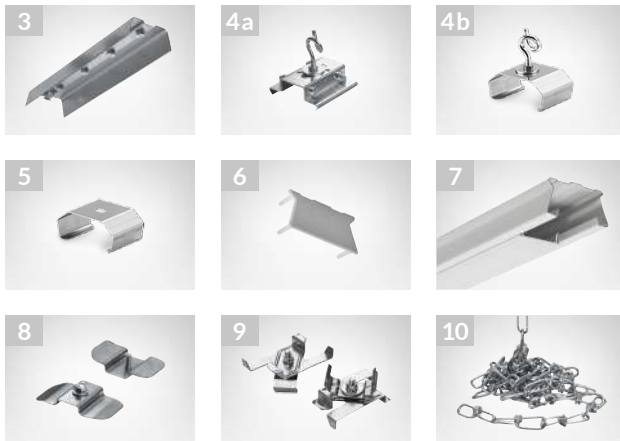

Type	Article No.	Gross €/pcs.
TRA trunking connector	3	3595 0007• 7.25
TRA trunking hanger	4a	For suspension of the trunking using a chain. Hanger can be fixed in place using screws. (order 1 per 2.5 m) 3595 0008• 4.38
TRA trunking hanger	4b	For suspension of the trunking using a chain. Tool-free installation: simply clip it onto the trunking. (order 1 per 2.5 m) 7414 9030• 2.75
TRA ceiling fixings	5	For direct ceiling mounting of the trunking. Tool-free installation: simply clip it onto the trunking. 7414 9031• 2.99
TRA trunking protective caps	6	Clip-on protective caps for trunking, white plastic. 3598 0046• 2.75
TRA cover strip 58/1	7	To close off open areas in the underside of the trunking, white plastic. 3598 0022• 7.00
TRA luminaire fastener	8	Luminaire fastener made of galvanised steel, internal. 3595 0004• 2.15
TRA luminaire fastener Type A	9	Luminaire mounting SET made of galvanised steel, external. Including retaining spring (narrow), suitable e.g. for PAC-D EL. 3596 2270• 2.45
TRA luminaire fastener Type B	9	Luminaire mounting SET Made of galvanised steel, external. Including retaining spring (wide), suitable e.g. for PAC-D Maxx + LZP. 3596 2280• 2.17
Chain	10	1 bundle, 30 m. 7414 9022• 40.60

• available ex stock



Mounting options with the TRA trunking system.



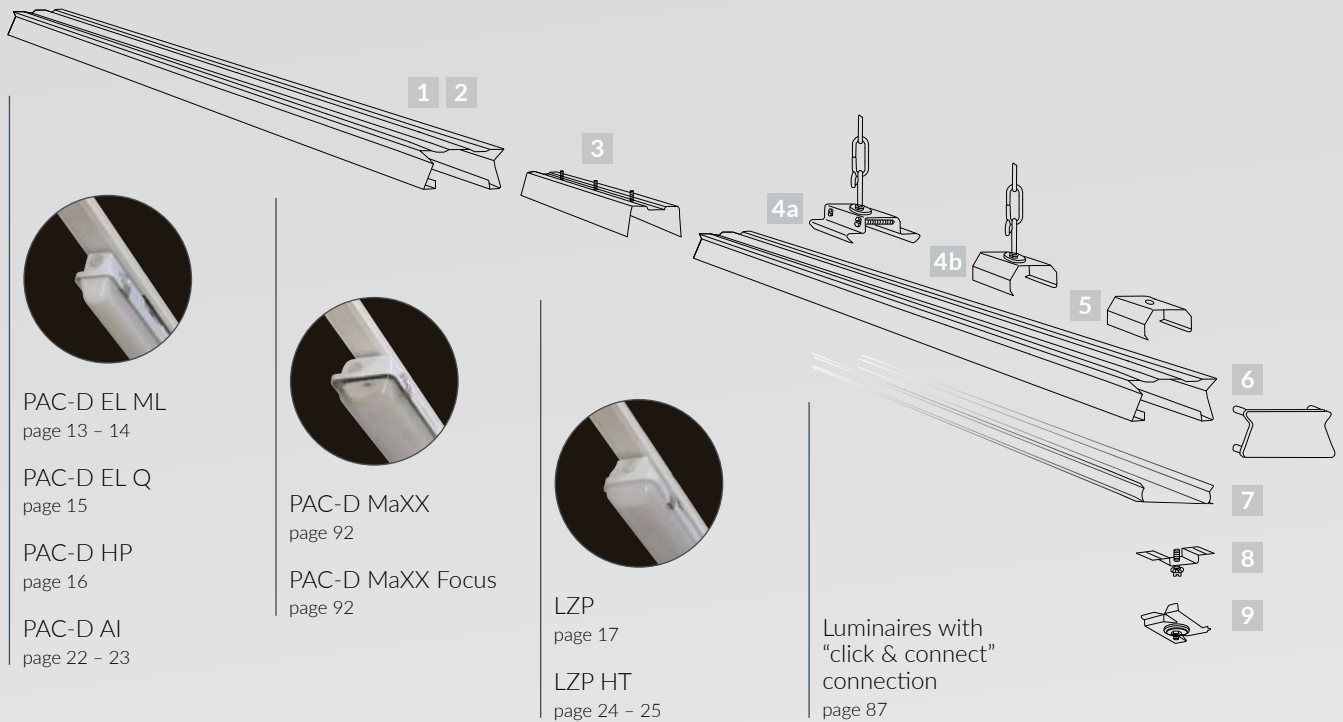

The empty trunking allows quick and flexible mounting of Fluolite moisture-proof luminaires. Using the appropriate mounting accessories (see page 81), each luminaire can be easily and variably mounted to create customised lighting solutions.



Create a complete trunking system in a few simple steps.

The TRA trunking system essentially consists of the following parts:

- 1 2 Trunking**
The trunking (available in two lengths) is mounted directly to the ceiling or suspended from steel cables/chains using the trunking hanger.
- 3 Trunking connector**
Connecting element for trunking. The connection is made without tools by simply plugging them together.
- 4a 4b Trunking hanger**
For suspension of the trunking. Includes a swing hook for attaching a chain (for example). In this way, many metres of trunking can be hung in a very short time.
- 5 Ceiling fixings for trunking**
Allows direct ceiling mounting of trunking. Tool-free installation: simply clip it onto the trunking.
- 6 Trunking protective caps**
The plastic protective caps form the end of the trunking and are quickly installed by simply clicking them in to place.
- 7 Cover strip**
The plastic cover strip can be used to close off any open areas in the underside of the trunking.
- 8 9 Luminaire fastener**
Pre-install the luminaire fastener on the luminaire, then connect the luminaire to the trunking system.

Total system length (m)	Trunking inserts							
		1 TRA 58/2 3065 mm	2 TRA 58/3 4595 mm					
3.06	2	1	-	-	2	2	2	2
4.60	3	-	1	-	3	3	3	2
6.12	4	2	-	1	4	4	4	2
7.66	5	1	1	1	5	5	5	2
9.20	6	-	2	1	6	6	6	2
10.73	7	2	1	2	7	7	7	2
12.26	8	1	2	2	8	8	8	2
13.80	9	-	3	2	9	9	9	2
15.32	10	2	2	3	10	10	10	2
16.85	11	1	3	3	11	11	11	2
18.38	12	-	4	3	12	12	12	2
19.92	13	2	3	4	13	13	13	2
21.45	14	1	4	4	14	14	14	2
22.98	15	-	5	4	15	15	15	2
24.51	16	2	4	5	16	16	16	2
26.05	17	1	5	5	17	17	17	2
27.58	18	-	6	5	18	18	18	2
29.11	19	2	5	6	19	19	19	2
30.65	20	1	6	6	20	20	20	2
32.17	21	-	7	6	21	21	21	2
33.70	22	2	6	7	22	22	22	2
35.23	23	1	7	7	23	23	23	2
36.76	24	-	8	7	24	24	24	2
38.30	25	2	7	8	25	25	25	2



Whatever your application, TRA is the solution.

Here are some pointers to help you choose the ideal TRA trunking system for your requirements.

Protection grade up to IP 66



Chemical resistance



Dust, ammonia



If you have any questions about project planning, please contact our sales team. We will be happy to answer any questions you may have about Fluolite products.

Luminaires with a higher protection grade are less vulnerable to the ingress of moisture and dust. The protection grade IP 65 meets the requirements for humid environments.

Diffusers made of PMMA (acrylic glass) are highly resistant to weathering and UV radiation and also offer excellent chemical resistance. They are also resistant to greases, oils, acids and alkaline cleaning agents.

In industrial and agricultural facilities with high dust loads or in applications with special cleaning requirements, additional factors must be considered when choosing a lighting solution.

+49 7542 517 0

info@fluolite.de

- ☛ PAC-D EL TRA c+c
- ☛ PAC-D EL ML
- ☛ LZP EL
- ☛ ALSF
- ☛ Euro-Line Aqua

- ☛ PAC-D EL TRA c+c
- ☛ PAC-D EL ML
- ☛ PAC-D AI

- ☛ PAC-D AI

ALSF
Euro-Line Aqua



CLICK & CONNECT capable

PAC-D EL ML
PAC-D HP



CLICK & CONNECT capable

PAC-D AI



CLICK & CONNECT capable

Large mounting heights



To ensure an optimal working environment in assembly, manufacturing and production facilities, you need modern, high-quality luminaires that provide the perfect light wherever it is needed.

- ☛ PAC-D HP TRA c+c
- ☛ PAC-D HP
- ☛ PAC-D MaXX TRA c+c
- ☛ PAC-D MaXX

Optimised Light distribution



Warehouses and storage racks consist of corridors with shelving areas that require adequate illumination. To optimise order picking through good lighting, uniform illumination of the vertical shelf surfaces must be ensured.

- ☛ PAC-D Maxx Focus TRA c+c
- ☛ PAC-D Maxx Focus

High and low temperatures



For reliable lighting in ambient temperatures below -20°C and above $+25^{\circ}\text{C}$, specially adapted LED luminaires are required.

- ☛ LZP HT

Food industry



The EU regulation on food hygiene, which came into force in 2006, makes it compulsory for anyone handling or placing food on the market to establish an HACCP concept.

Many of our luminaires that are compatible with the system are also HACCP certified.

- ☛ PAC-D EL TRA c+c
- ☛ PAC-D EL ML
- ☛ PAC-D AI
- ☛ LZP EL TRA c+c
- ☛ LZP EL
- ☛ LZP HT

PAC-D MaXX
TRA c+c

PAC-D MaXX
PAC-D MaXX Focus

LZP HT
LZP EL

PAC-D EL TRA c+c
PAC-D HP TRA c+c



CLICK & CONNECT capable

CLICK & CONNECT capable

TRA click & connect

“click & connect” RAPID INSTALLATION SYSTEM FOR TRUNKING



TRA CLICK & CONNECT

Click. Insert. Finished!

Time-saving and tool-free trunking installation in just a few steps

The click & connect system is an extremely practical solution for the installation of trunking. It is suitable for luminaires with a higher protection grade, as well as other types. The connector system is located inside the trunking.

- ☑ Inexpensive alternative to conventional trunking systems
- ☑ Trunking for wet areas up to IP 65
- ☑ Flexible luminaire positions and customised trunking lengths



TOOL-FREE

READY FOR CONNECTION

The luminaires have been optimised for mounting on the TRA trunking and can be flexibly positioned. The luminaire connections are mounted on the rear of the housing and run invisibly inside the trunking. The luminaires themselves are interconnected via the click & connect plug-in system.

With the luminaires spaced approx. 1.5 m apart, no additional interconnecting cable is required for installation.

*The cable length between the luminaire and the plug/socket is approx. 0.75 m. The entire luminaire installation process is tool-free.

With “click & connect”, a section of trunking can be mounted (click) and connected (connect) to the rail in next to no time.



TRA C+C PAC-D EL | PAC-D HP | PAC-D MaXX

LED LUMINAIRES WITH "click & connect" CONNECTION



Luminaire details
PAC-D EL ML
 page 13 – 14
PAC-D HP
 page 16



Luminaire details
PAC-D MaXX
 page 92



Ready for connection with through-wiring. The power cable (with plug) and output cable (with socket) on the luminaire comply with fire protection class B2ca. The luminaire fasteners for our TRA trunking are already pre-assembled.

- ☛ Up to 18,000 lumens
- ☛ Luminous efficacy up to 164 Lm/W (eligible for funding)
- ☛ Safe for use in the food industry – HACCP-certified
- ☛ Sustainable product thanks to replaceable LED module

- ☛ Colour tolerance (initial MacAdam) 3
- ☛ ▽ - symbol, suitable for rooms with an elevated fire risk
- ☛ For more "click & connect" capable luminaires see page 84 – 85

Type	Version	Colour temp. (K)	Luminous flux (Lm)	System power (W)	LED lifetime	L	E (± 60 mm)	PU	Article No.	Gross €/pcs.
PAC-D EL TRA c+c	1500 TW 5 x 2.5	4000	5900	43	50,000 h L80/B10	1520	1060	80	6324 1590 •	219.00
PAC-D HP TRA c+c	1500 TW 5 x 2.5	4000	9000	60	50,000 h L80/B10	1520	1060	80	6323 8266	319.00
PAC-D MaXX TRA c+c	1550 TW 5 x 2.5	4000	18,000	110	60,000 h L80/B10	1585	1060	80	6323 8430	359.00

• available ex stock | For suitable replacement diffusers and accessories see page 110+

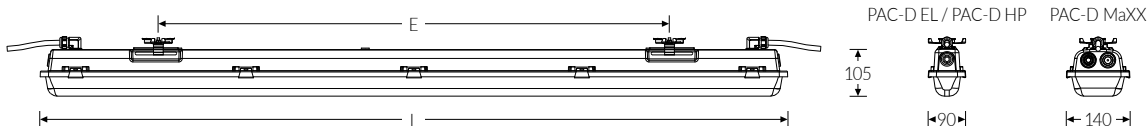

Pre-assembled wiring accessories



Power supply



Interconnecting cable



Sealing cap for socket

Type	Article No.	Gross €/pcs.
TRA click + connect power cable 1 m	3099 0060 •	28.50
TRA click + connect power cable 2 m	3099 0062	32.50
TRA click + connect power cable 3 m	3099 0064 •	37.00
TRA click + connect power cable 5 m	3099 0066	51.25
TRA click + connect interconnecting cable 2 m	3099 0063	44.00
TRA click + connect interconnecting cable 3 m	3099 0065	47.25
TRA click + connect interconnecting cable 5 m	3099 0067	62.75
TRA click + connect sealing cap for socket	3099 0070 •	2.00

• available ex stock



TRA click & connect online:
www.fluolite.de/produkte/serie/tra-click-connect

HOW MAY WE ASSIST YOU?

Advice. Service. After-sales.



 +49 7542 517 0

 info@fluolite.de

 www.fluolite.de/kontakt

FLUOLITE

COMPETENCE IN
LIGHT & LUMINAIRES



Minimum dimensions. LED batten made of aluminium with switch for under-cabinet mounting. Includes 2-metre interconnecting cable with plug, 2 mounting brackets each for direct and 90° angle installation, coupling and short interconnecting cable (approx. 30 cm) for line mounting. With switch, individually switchable. Can also be used for line mounting with max. 10 units next to each other. Opal translucent luminaire cover.

- ☛ Colour temperature (optional) 3000 K | 4000 K
- ☛ Interconnecting cable available in two lengths
- ☛ Suitable for line mounting
- ☛ Protection class II

- ☛ **Batten made from high-quality aluminium**
- ☛ **Available in five lengths**
- ☛ **Direct or 90° angle installation**

Type	Colour temp. (K)	Luminous flux (Lm)	System power (W)	LED lifetime	L	W	H	PU	Article No.	Gross €/pcs.
Minilite 3.3	3000	274	3.3	20,000h L80/B10	315	28	35	12	6455 0350 •	29.90
	4000	274	4.0	20,000h L80/B10	315	28	35	12	6455 0050 •	29.90
Minilite 5.76	3000	485	5.8	20,000h L80/B10	545	28	35	12	6455 0400 •	40.80
	4000	485	5.8	20,000 h L80/B10	545	28	35	12	6455 0100 •	40.80
Minilite 9.36	3000	790	9.4	20,000 h L80/B10	875	28	35	12	6455 0450 •	49.00
	4000	790	9.4	20,000h L80/B10	875	28	35	12	6455 0150 •	49.00
Minilite 12.6	3000	1114	12.6	20,000h L80/B10	1175	28	35	12	6455 0500 •	60.80
	4000	1114	13.2	20,000h L80/B10	1175	28	35	12	6455 0200 •	60.80
Minilite 16.2	3000	1352	16.2	20,000 h L80/B10	1475	28	35	12	6455 0550 •	78.30
	4000	1352	16.2	20,000 h L80/B10	1475	28	35	12	6455 0250 •	78.30

• available ex stock



Accessories

Use the interconnection adapter or the interconnecting cable (approx. 30 cm) to connect between two and ten MINILITE LEDs to one trunking rail (included in the scope of delivery). If required, an interconnecting cable (approx. 50 cm) can be ordered as an accessory.



Line mounting with interconnection adapter



Interconnecting cable

Type	Article No.	Gross €/pcs.
Interconnecting cable – length 50 cm	3006 0106 •	6.30







High-bay luminaires



PAC-D MaXX | 92
PAC-D MaXX Focus



HiLu ML 93

To ensure safe and productive working conditions in assembly facilities, factories and warehouses, optimal lighting is essential.

Industrial buildings often have higher ceilings compared to standard rooms, which is why LED luminaires with a higher luminous flux and special beam types are often used in these facilities.

PAC-D MaXX | PAC-D MaXX Focus

LED MOISTURE-PROOF LUMINAIRE WITH DIFFUSER

CE



LED luminaire for "HIGH" demands

The PAC-D MaXX is the perfect choice for rooms with high ceilings. Its strengths include a high luminous flux and excellent durability combined with an IP 65 protection grade, making this high-bay moisture-proof luminaire the perfect choice for harsh industrial environments.

Ideal for logistics and storage halls, industrial halls, exhibition halls as well as manufacturing and production facilities. Approved for use indoors and in covered outdoor areas.

Luminaire housing made of glass-fibre-reinforced polyester, light grey, flame retardant. PMMA diffuser, transparent, smooth outside, pearled inside. High-quality closures made of stainless steel (V2A).

- ☛ Up to 18,000 lumens
- ☛ Suitable for rooms and halls with high ceilings
- ☛ Homogeneous surface illumination, optimised light distribution
- ☛ Luminous efficacy up to 164 Lm/W (eligible for funding)
- ☛ Sustainable product thanks to replaceable LED module
- ☛ AC/DC capable

- ☛ Long LED lifetime – 60,000 h for L80/B10
- ☛ Colour tolerance (initial MacAdam) 3
- ☛ Ambient temperature from –20°C to +35°C
- ☛ Plastic closures optionally available
- ☛ - symbol, suitable for rooms with an elevated fire risk
- ☛ Optionally available with DALI (CLO-compatible)

	PAC-D MaXX	PAC-D MaXX Focus
	Efficient and uniform illumination for high-ceilinged rooms and halls.	Powerful lighting solution with linear lenses, ideal for shelf systems and aisles.
Colour temperature (K)	4000	4000
Luminous flux (Lm)	18,000	17,600
System power (W)	110	110
Luminous efficacy (Lm/W)	164	160
LED lifetime	60,000 h L80/B10	60,000 h L80/B10
Pallet unit (PU)	130	120
Article No.	6323 8420 •	6323 8450 •
Gross € / unit	249.40	297.00

Light distribution

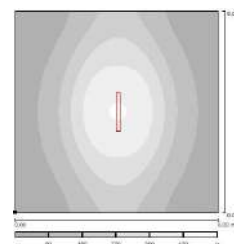
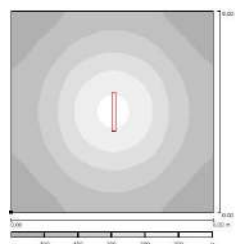

• available ex stock | For suitable replacement diffusers and accessories see page 110+

Installation options:

Walls, ceiling, trunking, suspended mounting.

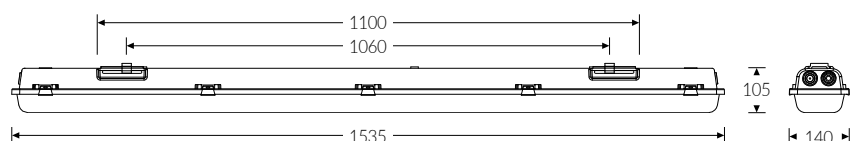

NEW



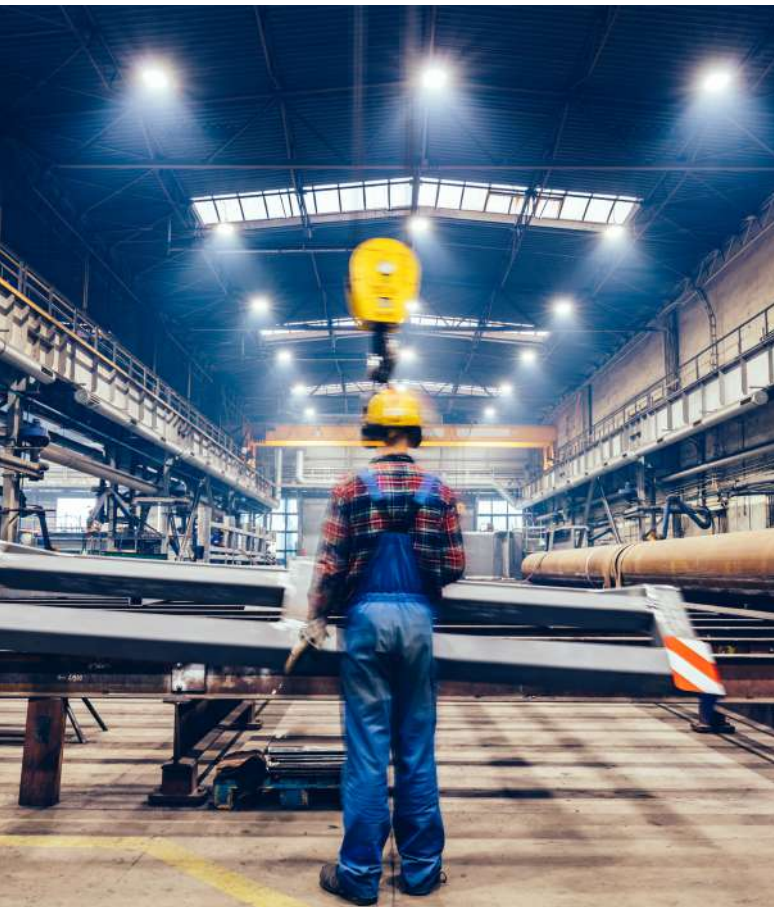

HiLu ML

LED HIGH-BAY LUMINAIRE

CE  IK08 IP65

High-quality LED high-bay luminaire with integrated driver, dimmable. The solid die-cast aluminium housing with integrated cooling fins offers superior thermal conductivity. Includes suspension eye and power cable (approx. 1.5 m). Mounting chain optionally available. Ideal for rooms with high ceilings, trade fair and exhibition halls, production facilities, warehouses, logistics centres.









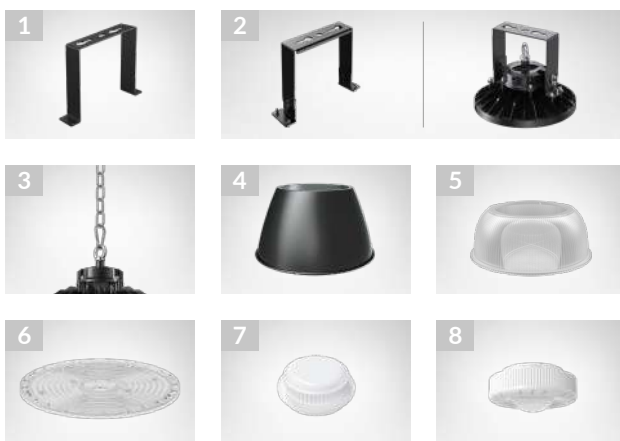

-  **Multilumen function**
-  **Up to 37,800 lumens at 200 W**
-  **Efficient illumination of rooms with high ceilings thanks to lens optics with wide beam types**
-  Suitable for use in humid environments thanks to a high protection grade (IP 65)
-  Ambient temperature from -30°C to +45°C

Type	Colour temp. (K)	Luminous flux (Lm)	System power (W)	LED lifetime	Ø	H (incl. eyelet)	Article No.	Gross €/pcs.
HiLu 300 ML	4000	37,800 / 22,300	200 / 120	50,000 h L80/B10	300	170	7827 5500 *	309.00
HiLu 300 DALI	4000	38,500	200	50,000 h L80/B10	300	170	7827 5510	362.00

* available ex stock

Accessories / Installation components



Type	Article No.	Gross €/pcs.
Fixed bracket  Rigid	3597 0310	25.50
Flex bracket  Can be swivelled 90°	3597 0311	47.20
Chain suspension  Stainless steel, length 50 cm, includes carabiner	3597 0312	15.10
ALU reflector  Aluminium, black Ø 480 x H 260 mm	3597 0314	72.10
PC reflector  Transparent Ø 480 x H 165 mm	3597 0315	72.10
Lens attachment  90° transparent	3597 0313	16.20
HF sensor  Daylight-controlled presence detector (HF)	3597 0316	57.90
PIR sensor  Daylight-controlled presence detector (infrared)	3597 0317	61.50



HiLu ML online:
www.fluolite.de/produkte/unterkategorie/hallenbeleuchtung





Ball-proof luminaires

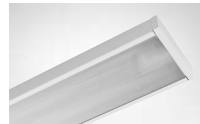

InAct 96



Salem FL 97

Standardised glare control, low reflections and certified ball-impact resistance provide a sound basis for compliance with diverse mechanical and lighting requirements. Perfect visibility is an essential aspect of creating the ideal conditions for training and competitions.

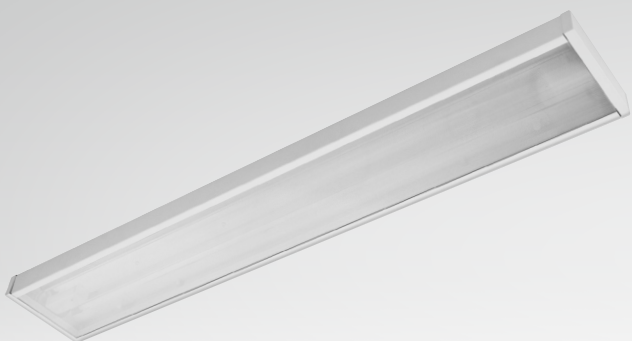

Sleek. Economical. Sophisticated.

LED high-bay luminaire including power supply unit, dimmable. Steel housing, coated white. Microprismatic cover made of high-impact polycarbonate (PC), ball-proof and robust. This makes it particularly suitable for use in sports and multi-purpose halls.

The scope of delivery includes suspension eyes, connection cable (approx. 30 cm) with mounted connection plug and enclosed connection socket.

- ⚡ **Powerful and ball-proof**
- ⚡ **High protection grade IP 65, high shock resistance to IK 10**
- ⚡ **DALI dimmable**
- ⚡ **Luminous efficacy up to 125 Lm/W** (eligible for funding)

- ⚡ Ambient temperature from -15°C to +45°C
- ⚡ Colour tolerance (initial MacAdam) 3
- ⚡ Unified Glare Rating (UGR) < 22
- ⚡ Diverse installation options
- ⚡ Homogeneous light, accurate colour rendering, optimum glare control

Type	Version	Colour temp. (K)	Luminous flux (Lm)	System power (W)	LED lifetime	L	W	Article No.	Gross €/pcs.
InAct-LED BP 2/L MP	DALI	4000	11,500	92	80,000h L80/B50	1224	197	8717 5000	650.00
InAct-LED BP 4/L MP	DALI	4000	22,700	182	80,000h L80/B50	1224	357	8717 5010	1,038.00

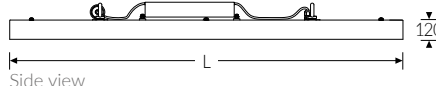
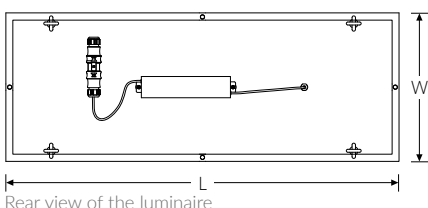

InAct-LED BP 2/L MP



InAct-LED BP 4/L MP

Accessories / Installation components

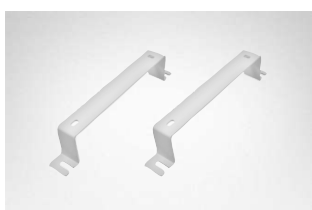

Retaining bracket for direct surface mounting

Type	Article No.	Gross €/pcs.
Surface-mounting set for InAct-LED BP 2/L (2 pcs.)	3596 2755	18.80
Surface-mounting set for InAct-LED BP 4/L (2 pcs.)	3596 2760	24.80
Installation frame for InAct-LED BP 2/L	3596 2765	189.00
Installation frame for InAct-LED BP 4/L	3596 2770	249.00



NEW Salem FL

LED SPORTS HALL LUMINAIRE

CE IK08 IP40



Certified ball-impact resistance

Flicker-free LED technology

Long-lasting and energy-efficient

Luminous efficacy up to 163 Lm/W (eligible for funding)

Compact and robust with lens optics.

Ball-proof, compact luminaire with a slim yet robust white aluminium housing. Acrylic lenses (PMMA). Optimum light control thanks to lens technology that is suitable for a wide range of applications. Suitable for wall, ceiling or suspended mounting. Ideal for use in industrial facilities and sports halls.

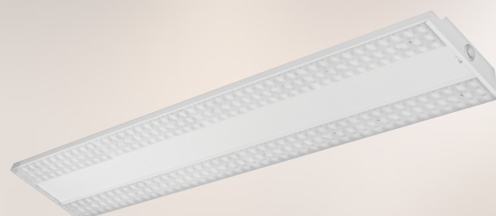

- ☛ Ambient temperature from -15°C to +45°C
- ☛ Colour tolerance (initial MacAdam) 3
- ☛ Wide light cone (90°) for broad illumination
- ☛ Optionally available with 60° and asymmetrical light-distribution angles

Type	Version	Colour temp. (K)	Luminous flux (Lm)	System power (W)	LED lifetime	L	W	E	Article No.	Gross € / pcs.
Salem FL	DALI	4000	26,000	160	80,000h L80/B50	1735	213	1160	8486 8000	652.10

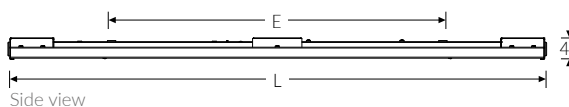
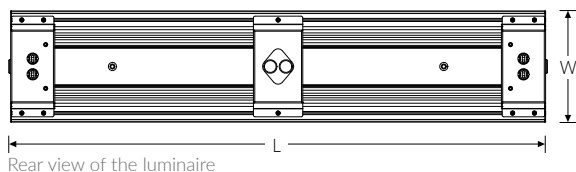

Acrylic lens technology (PMMA)



Snap hook for suspension included in the scope of delivery

Accessories / Replacement parts

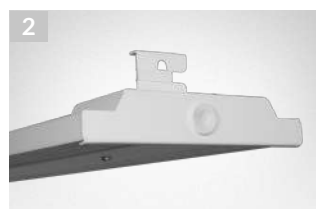
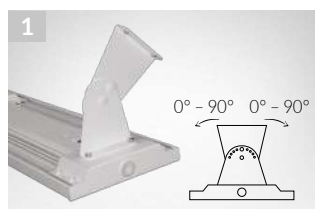

Type	Article No.	Gross € / pcs.
Wall / ceiling fixings (swivelling 180°)	1 3597 0295	21.33
Pipe / cable attachment	2 3597 4098	11.00



Salem FL online:
www.fluolite.de/produkte/serie/salem-fl



Luminaires for LEDtubes



PAC-D 99



PACN | PACE 99



LZP 100



Euro-FFL 100



ALSF 101



Euro-Line Aqua 101



AOT 102



Euro-Line 102



LUX 103



TRX 104



SFN / SFX 104



Retrofit luminaires



RKL 105



RKL-Aqua 105

Choose from our wide range of luminaires for LEDtubes and retrofit luminaires to realize professional lighting solutions – with light sources that can be easily changed at any time without specialist help.

Moisture-proof luminaires with diffusers



For illustration only. Stainless-steel closures.

PAC-D for LEDtube

CE U D IP65

Luminaire housing made of glass-fibre reinforced polyester, light grey, flame retardant. Acrylic diffuser (PMMA), transparent, smooth outside, frosted inside. High-quality closures made of stainless steel (V2A). Multifunctional stainless-steel mounting brackets for rapid installation (luminaire can be clipped in). Laterally adjustable by up to 60 mm for easy alignment of the luminaire.

☑ With integrated micro-fuse for protection against excess voltage

Type		L	E (± 60 mm)	PU	Article No.	Gross €/pcs.	
PAC-D	1 x LEDtube	1200	1270	820	120	6071 5520 •	38.40
		1500	1570	1120	120	6074 5520 •	42.90
PAC-D	2 x LEDtube	1200	1285	820	130	6082 5520 •	43.80
		1500	1585	1120	130	6083 5520 •	53.00

• available ex stock | For suitable accessories see page 113

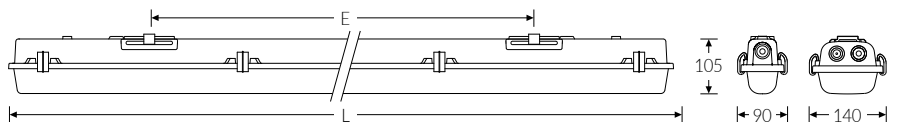

PAC-D for LEDtube online:

www.fluolite.de/produkte/serie/pac-d-fuer-ledtube



For illustration only. Stainless-steel closures.

PAC for LEDtube

CE U D IP65

Luminaire housing made of glass-fibre-reinforced polyester, light grey, flame retardant. Acrylic diffuser (PMMA), transparent, smooth outside, frosted inside. High-quality closures made of stainless steel (V2A).

☑ With integrated micro-fuse for protection against excess voltage

Type		L	E	PU	Article No.	Gross €/pcs.	
PACN	1 x LEDtube	1200	1270	800	120	6071 6122 •	37.30
		1500	1570	1100	120	6074 6125 •	42.00
PACE	2 x LEDtube	1200	1285	800	130	6082 6222 •	43.90
		1500	1585	1100	130	6083 6225 •	53.50

• available ex stock | For suitable accessories see page 113

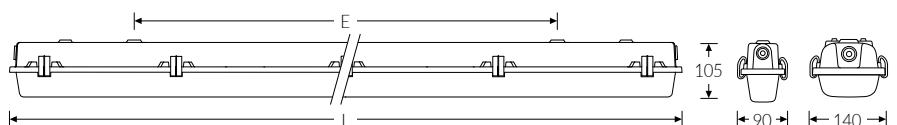

PAC for LEDtube online:

www.fluolite.de/produkte/serie/pac-d-fuer-ledtube

Moisture-proof luminaires with diffusers



LZP for LEDtube

CE IK07 IP66

Luminaire housing made of glass-fibre-reinforced polyester, light grey, flame retardant. Injection-moulded polycarbonate (PC) diffuser with internal prisms. High-quality closures made of stainless steel (V2A). Multifunctional stainless-steel mounting brackets for rapid installation (luminaire can be clipped in). Laterally adjustable by up to 60 mm for easy alignment of the luminaire.

With integrated micro-fuse for protection against excess voltage

Type		L	Emin.	E _{max.}	PU	Article No.	Gross €/pcs.	
LZP	1 x LEDtube	600	660	265	385	200	6101 6120 •	39.50
		1200	1265	805	925	100	6102 6122 •	49.90
		1500	1565	1105	1225	100	6103 6125 •	53.80
LZP	2 x LEDtube	600	660	265	385	60	6104 1522 •	49.90
		1200	1265	805	925	60	6105 6222 •	63.80
		1500	1565	1105	1225	60	6106 6225 •	71.30

• available ex stock | For suitable accessories see page 113

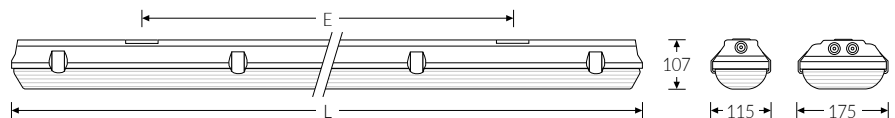

LZP for LEDtube online:
www.fluolite.de/produkte/serie/lzp-fuer-ledtube

Uncovered moisture-proof luminaire



Euro-FFL for LEDtube

CE IK07 IP65

Slimline luminaire housing made of glass-fibre-reinforced polyester, light grey, flame retardant. With quick-release closure. Protection class II. Includes lamp protection tube (LS tube) made of polycarbonate (PC) Ø 38 mm.

With integrated micro-fuse for protection against excess voltage

Type		L	E	PU	Article No.	Gross €/pcs.	
Euro-FFL	1 x LEDtube	1200	1265	800	80	6181 6122 •	47.40
		1500	1565	1100	80	6184 6125 •	51.70
Euro-FFL	2 x LEDtube	1200	1265	800	80	6181 7122	65.30
		1500	1565	1100	80	6189 7125 •	74.70

• available ex stock

Euro-FFL fastening set

Set includes 2 retaining clips, 2 chain / cable hangers, 2 sealing plugs.

3596 2170 13.70

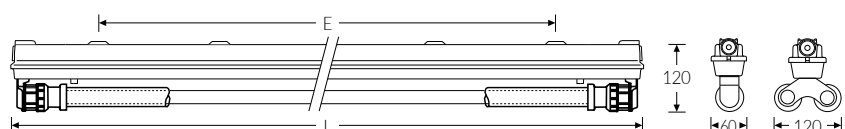
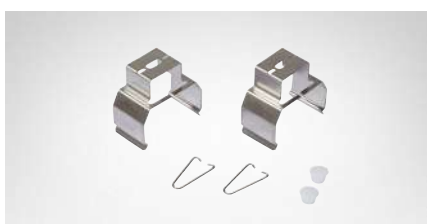

Euro-FFL for LEDtube online:
www.fluolite.de/produkte/serie/euro-ffl-fuer-ledtube

Moisture-proof surface-mounted luminaires



ALSF for LEDtube

CE IP54

Luminaire housing made of glass-fibre-reinforced polyester, light grey, flame retardant. With opal or prismatic acrylic diffuser (PMMA). Angular design

With integrated micro-fuse for protection against excess voltage

Type		L	E	PU	Article No.	Gross €/pcs.	
ALSF Opal	1 x LEDtube	600	600	430	250	6009 5000	54.80
		1200	1260	740	150	6010 2145	65.00
		1500	1560	850	150	6013 2145	74.00
	2 x LEDtube	1500	1560	850	80	6018 2340	88.00
	ALSF Prismatic	1 x LEDtube	1200	1260	740	150	6010 2140
1500			1560	850	150	6013 2140	74.00
2 x LEDtube			1200	1260	740	80	6015 2240
1500		1560	850	80	6018 2240	88.00	

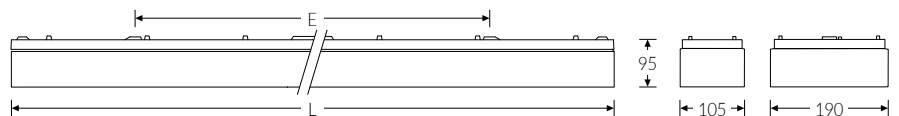

ALSF for LEDtube online:
www.fluolite.de/produkte/serie/alsf-fuer-ledtube



Euro-Line Aqua for LEDtube

CE IP54

Luminaire housing made of glass-fibre-reinforced polyester, light grey, flame retardant. With opal or prismatic acrylic diffuser (PMMA). Bevelled diffuser design.

With integrated micro-fuse for protection against excess voltage

Type		L	E	PU	Article No.	Gross €/pcs.	
Euro-Line Aqua Opal	1 x LEDtube	1200	1270	740	150	6010 2135	64.00
		1500	1570	850	150	6013 2135	74.00
	2 x LEDtube	1200	1270	740	80	6015 2235	79.50
		1500	1570	850	80	6018 2235	94.00
Euro-Line Aqua Prismatic	1 x LEDtube	1200	1270	740	150	6010 2130	64.00
		1500	1570	850	150	6013 2130	79.50
	2 x LEDtube	1200	1270	740	80	6015 2230	72.60
		1500	1570	850	80	6018 2230	94.00

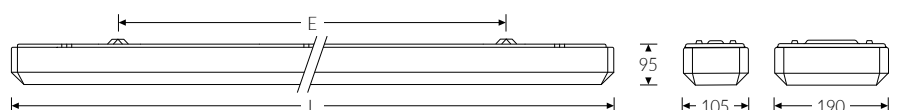

Euro-Line Aqua for LEDtube online:
www.fluolite.de/produkte/serie/euro-line-aqua-fuer-ledtube

Diffuser surface-mounted luminaires



AOT for LEDtube

CE IP50

Luminaire housing made of white lacquered steel. Angular, smooth opal or prismatic acrylic diffuser (PMMA).

☑ With integrated micro-fuse for protection against excess voltage

Type		L	E	PU	Article No.	Gross €/pcs.	
AOT Opal	1 x LEDtube	600	650	460	200	7030 2000	38.80
		1200	1260	900	200	7120 2150	58.00
		1500	1560	1200	150	7123 2150	63.50
	2 x LEDtube	1500	1560	1200	80	7129 2150	73.70
	AOT Prismatic	1 x LEDtube	1200	1260	900	200	7120 2140
1500			1560	1200	150	7123 2140	63.50
2 x LEDtube			1200	1260	900	80	7126 2140
1500		1560	1200	80	7129 2140	73.70	

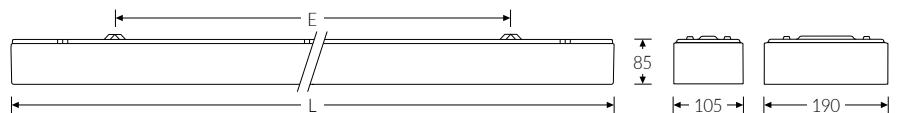

AOT for LEDtube online:
www.fluolite.de/produkte/serie/aot-fuer-ledtube



Euro-Line for LEDtube

CE IP50

Luminaire housing made of white lacquered steel. Elegant diffuser design with bevelled edges made of acrylic (PMMA), opal or prismatic.

☑ With integrated micro-fuse for protection against excess voltage

Type		L	E	PU	Article No.	Gross €/pcs.	
Euro-Line Opal	1 x LEDtube	1200	1270	900	200	7120 2135	59.00
		1500	1570	1200	150	7123 2135	64.00
	2 x LEDtube	1200	1270	900	80	7126 2135	66.00
		1500	1570	1200	80	7129 2135	74.90
Euro-Line Prismatic	1 x LEDtube	1200	1270	900	200	7120 2130	59.00
		1500	1570	1200	150	7123 2130	64.00
	2 x LEDtube	1200	1270	900	80	7126 2130	66.00
		1500	1570	1200	80	7129 2130	74.90

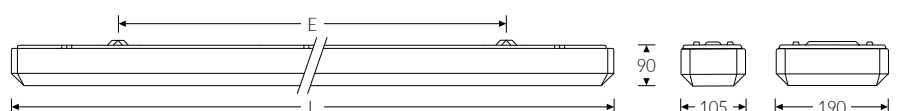

Euro-Line for LEDtube online:
www.fluolite.de/produkte/serie/euro-line-fuer-ledtube

Louvre surface-mounted luminaire

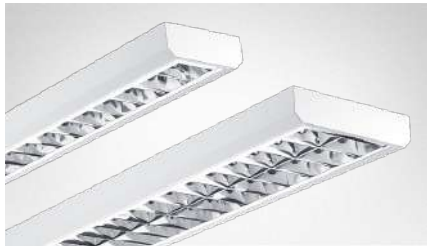

LUX for LEDtube

CE IP20

Sturdy housing made of steel, white, modern low-profile design.
Specular louvre, high-gloss aluminium.

☛ **With integrated micro-fuse for protection against excess voltage**

Type		L	E	PU	Article No.	Gross €/pcs.	
LUX	1 x LEDtube	1200	1260	950	40	8486 5050 •	59.60
		1500	1560	1250	40	8486 6050 •	71.80
LUX	2 x LEDtube	1200	1260	950	40	8486 5055 •	71.80
		1500	1560	1250	40	8486 6055 •	76.70

• available ex stock

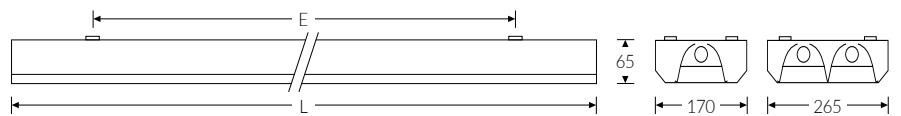

LUX for LEDtube online:
www.fluolite.de/produkte/serie/lux-fuer-ledtube

Trunking system



TRX for LEDtube

CE IP20

Trunking system that can be installed quickly and easily without tools. The TRX LED light units are suitable for new installations and as replacements for existing battens on trunking with a length of 1530 mm.

For the required TRX trunking elements and a wide range of accessories see page 77 or visit www.fluolite.de/produkte/serie/trx-system

☑ With integrated micro-fuse for protection against excess voltage

Type		L	PU	Article No.	Gross €/pcs.
TRX light unit	1 x LEDtube	1500	1530	6/180	7424 6125 • 34.00
TRX light unit	2 x LEDtube	1500	1530	6/180	7429 6225 • 39.50

• available ex stock

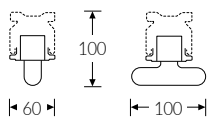

TRX for LEDtube online:
www.fluolite.de/produkte/serie/trx-fuer-ledtube

Uncovered batten



SFN / SFX for LEDtube

CE IP20

Steel housing, finished in white, with continuous ceiling plate. Suitable for ceiling and wall mounting and for use as trunking in conjunction with our TRA system.

☑ With integrated micro-fuse for protection against excess voltage

Type		L	H	PU	Article No.	Gross €/pcs.
SFN	1 x LEDtube	600	630	100	204	7395 6125 32.00
		1200	1230	100	204	7396 6125 • 42.90
		1500	1530	100	200	7398 6125 • 46.90
SFX	2 x LEDtube	1200	1230	105	204	7396 6230 46.40
		1500	1530	105	204	7398 6230 53.90

• available ex stock

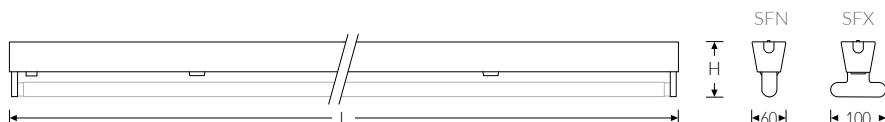

SFN / SFX für LEDtube online:
www.fluolite.de/produkte/serie/sfnfx-fuer-ledtube

Retrofit luminaires



RKL wall and ceiling luminaire

CE IP40

Luminaire housing made of steel, white. Opal diffuser made of textured acrylic (PMMA).

Type	Version	Ø	H	PU	Article No.	Gross €/pcs.
RKL 2	1 x E27	300	105	175	7510 1100 •	30.20
	1 x E27 HF sensor	300	105	175	7510 1103 •	80.50
RKL 3	2 x E27	375	125	100	7511 1100 •	36.00
	2 x E27 HF sensor	375	125	100	7511 1103 •	84.00
RKL 4	2 x E27	475	150	50	7512 1200 •	56.70
	2 x E27 HF sensor	475	150	50	7512 1303	82.50
	3 x E27	475	150	50	7512 1300 •	58.00
RKL 6	4 x 40 E27	600	165	28	7513 1270 •	90.70

• available ex stock | For suitable replacement diffusers see page 111

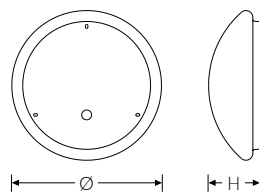

RKL for retrofit online:
www.fluolite.de/produkte/serie/rkl-retrofit



RKL-Aqua wall and ceiling luminaire

CE IP65

Luminaire housing made from polycarbonate (PC), white. Opal diffuser made of textured acrylic (PMMA).

Type	Version	Ø	H	PU	Article No.	Gross €/pcs.
RKL-Aqua 2	1 x E27	300	115	165	7518 1100 •	46.50
RKL-Aqua 3	2 x E27	375	135	100	7519 1100 •	57.00
RKL Aqua 4	1 x E27	480	160	45	7520 1100	74.30

• available ex stock

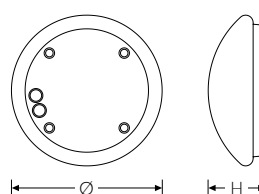

RKL-Aqua for retrofit online:
www.fluolite.de/produkte/serie/rkl-retrofit

Rescue and safety luminaires



FLS 1 Display
Autotest 107



FL 2 Autotest 108



FL 4 Autotest 108



FL 3 Display-E
Autotest 109



FL 3 Display-R
Autotest 109

These standardised and tested LED rescue and safety luminaires with automatic self-test are durable, efficient and low-maintenance products.

Their high build quality, switchable running times (3 h / 8 h) and optimised lighting technology ensure dependable functionality in an emergency.

FLS 1 Autotest

LED RESCUE AND SAFETY LUMINAIRE



Reliable and safe thanks to automatic self-test

Single-accumulator emergency exit sign luminaire in "flat-screen" design, complies with EN 60598-2-22 (VDE 0711 Part 2.22), with auto-test function and built-in test switch for manual testing, including function display. Operating mode suitable for continuous and stand-by operation. This powerful rechargeable accumulator makes it possible to switch the light from 3 to 8 hours of accumulator operation if required. Suitable for wall and ceiling mounting. Suspended or bracket mounting on request. Includes four plug-in pictograms – escape route direction can be shown as required on 1 or 2 sides.

- ☛ Modern "flat screen" design
- ☛ Automatic test function
- ☛ Accumulator operation, switchable between 3 and 8 hours
- ☛ With powerful lithium iron phosphate (LiFePO4) accumulator
- ☛ Legible at up to 25 m

Housing: polycarbonate, white, impact resistant, shatterproof
 Profile: anodised aluminium
 Legible at up to: 25 m
 Labelling: two-sided
 Autonomy: switchable from 3 hours to 8 hours
 Power source: LiFePO accumulator 3.2 V / 1.6 Ah
 Temperature range: +5°C to +40°C

Type	Luminous flux (Lm)	System power (W)	L1	L2	H1	H2	H3	W1	W2	PU	Article No.	Gross €/pcs.
FLS 1 DISPLAY Autotest	110	2	242	213	151	201	155	110	46	150	6056 5000 •	179.00

• available ex stock

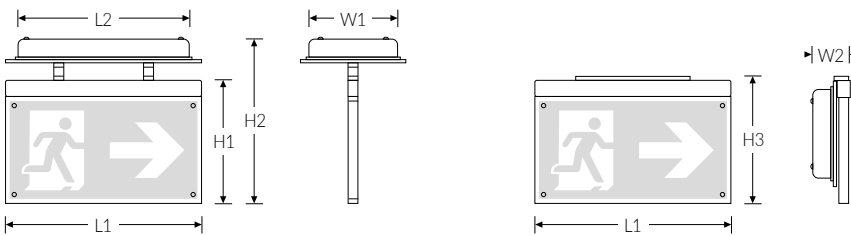

FLS 1 Autotest for ceiling mounting



FLS 1 Autotest for wall mounting



FLS 1 Autotest online:
www.fluolite.de/produkte/serie/fls-1

FL 2 Autotest

LED RESCUE AND SAFETY LUMINAIRE



- Automatic test function
- Accumulator operation, switchable between 3 and 8 hours
- High-quality plastic housing made of UV-resistant, thermally stable polycarbonate

Single-accumulator emergency exit sign luminaire, complies with EN 60598-2-22 (VDE 0711 Part 2.22), with auto-test function and built-in test switch for manual testing. Signalling via multi-coloured LED. Operating mode suitable for continuous and stand-by operation. This powerful rechargeable accumulator makes it possible to switch the light from 3 to 8 hours of accumulator operation if required. Suitable for wall and ceiling mounting. Includes pictogram films.

Housing: polycarbonate, white, impact resistant, shatterproof
 Diffuser / cover: polycarbonate, opal, impact resistant, shatterproof
 Legible at up to: 18 m
 Labelling: three-sided
 Autonomy: switchable from 3 hours to 8 hours
 Power source: LiFePO accumulator 3.2 V / 1.6 Ah
 Temperature range: +5°C to +45°C

Type	Luminous flux (Lm)	System power (W)	LED lifetime	L	W	H	PU	Article No.	Gross €/pcs.
FL 2 Autotest	120	5	35,000 h L70/B20	360	90	130	220	6056 2020 •	102.30

• available ex stock

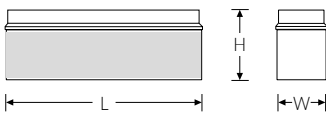

[FL 2 Autotest online](http://www.fluolite.de/produkte/serie/fl-2)
www.fluolite.de/produkte/serie/fl-2



FL 4 Autotest

LED RESCUE AND SAFETY LUMINAIRE



- Automatic test function
- Accumulator operation, switchable between 3 and 8 hours
- Luminaire can be opened without tools

Single-accumulator emergency exit sign luminaire, complies with EN 60598-2-22 (VDE 0711 Part 2.22), with auto-test function and built-in test switch for manual testing. Signalling via multi-coloured LED. Operating mode suitable for continuous and stand-by operation. This powerful rechargeable accumulator makes it possible to switch the light from 3 to 8 hours of accumulator operation if required. Suitable for wall and ceiling mounting. Includes pictogram films.

Housing: polycarbonate, white, impact resistant, shatterproof
 Diffuser / cover: polycarbonate, opal, impact resistant, shatterproof
 Legible at up to: 32 m
 Labelling: two-sided
 Autonomy: switchable from 3 hours to 8 hours
 Power source: LiFePO accumulator 3.2 V / 1.6 Ah
 Temperature range: +5°C to +45°C

Type	Luminous flux (Lm)	System power (W)	LED lifetime	L	W	H	PU	Article No.	Gross €/pcs.
FL 4 Autotest	120	5	35,000 h L70/B20	360	90	200	168	6056 2040 •	109.70

• available ex stock

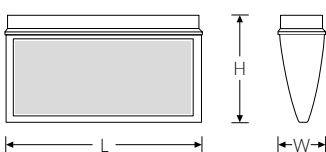

[FL 4 Autotest online](http://www.fluolite.de/produkte/serie/fl-4)
www.fluolite.de/produkte/serie/fl-4



FL 3 Display-E Autotest

LED RESCUE AND SAFETY LUMINAIRE



Single-accumulator emergency exit sign luminaire, complies with EN 60598-2-22 (VDE 0711 Part 2.22), with auto-test function and built-in test switch for manual testing. Signalling via multi-coloured LED. Operating mode suitable for continuous and stand-by operation. This powerful rechargeable accumulator makes it possible to switch the light from 3 to 8 hours of accumulator operation if required. Suitable for wall and ceiling mounting. Includes pictogram films.

- Robust aluminium profile luminaire, can be opened without tools
- Automatic test function
- Accumulator operation, switchable between 3 and 8 hours

Housing: anodised aluminium, rectangular
 Diffuser / cover: polycarbonate, opal, impact resistant, shatterproof
 Legible at up to: 18 m
 Labelling: two-sided
 Autonomy: switchable from 3 hours to 8 hours
 Power source: LiFePO accumulator 3.2 V / 1.6 Ah
 Temperature range: +5°C to +40°C

Type	Luminous flux (Lm)	System power (W)	LED lifetime	L	W	H	PU	Article No.	Gross €/pcs.
FL 3 DISPLAY-E Autotest	40	5	35,000h L70/B20	290	85	165	50	6056 2025 *	169.00

* available ex stock



FL 3 DISPLAY-E Autotest online:
www.fluolite.de/produkte/serie/fl-3

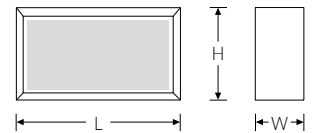

FL 3 Display-R Autotest

LED RESCUE AND SAFETY LUMINAIRE



Single-accumulator emergency exit sign luminaire, complies with EN 60598-2-22 (VDE 0711 Part 2.22), with auto-test function and built-in test switch for manual testing. Signalling via multi-coloured LED. Operating mode suitable for continuous and stand-by operation. This powerful rechargeable accumulator makes it possible to switch the light from 3 to 8 hours of accumulator operation if required. Suitable for wall and ceiling mounting. Includes pictogram films.

- Robust aluminium profile luminaire, can be opened without tools
- Automatic test function
- Accumulator operation, switchable between 3 and 8 hours

Housing: anodised aluminium, rounded
 Diffuser / cover: polycarbonate, opal, impact resistant, shatterproof
 Legible at up to: 18 m
 Labelling: two-sided
 Autonomy: switchable from 3 hours to 8 hours
 Power source: LiFePO accumulator 3.2 V / 1.6 Ah
 Temperature range: +5°C to +40°C

Type	Luminous flux (Lm)	System power (W)	LED lifetime	L	W	H	PU	Article No.	Gross €/pcs.
FL 3 DISPLAY-R Autotest	40	5	35,000 h L70/B20	290	85	165	50	6056 2030 *	169.00

* available ex stock



FL 3 DISPLAY-R Autotest online:
www.fluolite.de/produkte/serie/fl-3

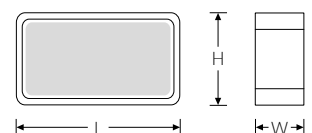

Replacement diffusers

MOISTURE-PROOF LUMINAIRES WITH DIFFUSERS



PAC-D EL opal replacement diffuser



LZP replacement diffuser

PAC-D opal

Type	Article No.	Gross €/pcs.	Compatible with	Page
PAC-D 600 opal diffuser	4380 0654	31.40	PAC-D EL ML 650	13
PAC-D 1200 opal diffuser	4384 0536 •	36.80	PAC-D EL ML 1200	13 - 14
			PAC-D EL Q 1200	15
			PAC-D AI 1200	22 - 23
PAC-D 1500 opal diffuser	4384 0546 •	39.50	PAC-D EL ML 1500	13 - 14
			PAC-D EL Q 1500	15
			PAC-D HP 1500	16
			PAC-D AI 1500	22 - 23
			PAC-D EL TRA c+c 1500	87
			PAC-D HP TRA c+c 1500	87

• available ex stock

PAC-D pearled

Type	Article No.	Gross €/pcs.	Compatible with	Page
PAC-D 1200 diffuser, pearled	4381 0336	34.00	PAC-D EL ML 1200	13 - 14
			PAC-D EL Q 1200	15
			PAC-D AI 1200	22 - 23
PAC-D 1500 diffuser, pearled	4384 0336	36.80	PAC-D EL ML 1500	13 - 14
			PAC-D EL Q 1500	15
			PAC-D HP 1500	16
			PAC-D AI 1500	22 - 23

PAC-D MaXX

Type	Article No.	Gross €/pcs.	Compatible with	Page
PAC-D 2/1550 diffuser, pearled	4389 0336	39.50	PAC-D MaXX TRA c+c 1550	87
			PAC-D MaXX 1550	92
			PAC-D MaXX Focus 1550	92

LZP

Type	Article No.	Gross €/pcs.	Compatible with	Page
LZP/PC 1250 opal diffuser	4361 8016	47.60	LZP 1250	17
			LZP HT 1250	24 - 25
LZP/PC 1550 opal diffuser	4362 8016 •	50.30	LZP 1550	17
			LZP HT 1550	24 - 25

• available ex stock

Replacement diffusers

WALL AND CEILING LUMINAIRES



RKL ML replacement diffuser



RKL-Z ML replacement diffuser

Weiler FL

Type	Article No.	Gross €/pcs.	Compatible with	Page
Weiler FL 2 opal diffuser	4560 0326	21.70	Weiler FL 2	44
Weiler FL 3 opal diffuser	4562 0326	24.40	Weiler FL 3	44
Weiler FL 4 opal diffuser	4564 0326	48.70	Weiler FL 4	44

Weiler-Z FL

Type	Article No.	Gross €/pcs.	Compatible with	Page
Weiler-Z FL 2 opal diffuser	4560 0316	21.70	Weiler-Z FL 2	45
Weiler-Z FL 3 opal diffuser	4562 0316	24.40	Weiler-Z FL 3	45
Weiler-Z FL 4 opal diffuser	4564 0316	48.70	Weiler-Z FL 4	45

RKL ML

Type	Article No.	Gross €/pcs.	Compatible with	Page
RKL 2 opal diffuser (PMMA diffuser)	4560 0026 •	21.70	RKL 2 ML	50
			RKL 2 Retrofit	105
RKL/PC 2 opal diffuser (PC diffuser)	4560 2426 •	24.70	RKL 2 ML	50
			RKL 2 Retrofit	105
RKL 3 opal diffuser (PMMA diffuser)	4562 0026 •	24.40	RKL 3 ML	50
			RKL 3 Retrofit	105
RKL/PC 3 opal diffuser (PC diffuser)	4562 2426 •	27.40	RKL 3 ML	50
			RKL 3 Retrofit	105
RKL 4 opal diffuser (PMMA diffuser)	4564 0026 •	48.70	RKL 4 ML	51
			RKL 4 Retrofit	105
RKL/PC 4 opal diffuser (PC diffuser)	4564 2426 •	51.70	RKL 4 ML	51
			RKL 4 Retrofit	105
RKL 6 opal diffuser (PMMA diffuser)	4566 0026 •	70.60	RKL 6 ML	51 - 52
			RKL 6 Retrofit	105
RKL/PC 6 opal diffuser (PC diffuser)	4565 2426	73.60	RKL 6 ML	51 - 52
			RKL 6 Retrofit	105

• available ex stock

Replacement diffusers

WALL AND CEILING LUMINAIRES

RKL-Z ML

Type	Article No.	Gross €/pcs.	Compatible with	Page
RKL-Z 2 opal diffuser (PMMA diffuser)	4560 0016 •	27.10	RKL-Z 2 LED ML	53 / 55
RKL-Z/PC 2 opal diffuser (PC diffuser)	4560 2416	31.70	RKL-Z 2 LED ML	53 / 55
RKL-Z 3 opal diffuser (PMMA diffuser)	4562 0016 •	32.60	RKL-Z 3 LED ML	53 / 55
RKL-Z/PC 3 opal diffuser (PC diffuser)	4562 2416	35.30	RKL-Z 3 LED ML	53 / 55
RKL-Z 4 opal diffuser (PMMA diffuser)	4564 0016 •	48.70	RKL-Z 4 LED ML	55
RKL-Z/PC 4 opal diffuser (PC diffuser)	4564 2416	51.70	RKL-Z 4 LED ML	55
RKL-Z 6 opal diffuser (PMMA diffuser)	4566 2426	70.60	RKL-Z 6 LED ML	55
RKL-Z/PC 6 opal diffuser (PC diffuser)	4566 2416	73.60	RKL-Z 6 LED ML	55

- available ex stock

Replacement gear trays

MOISTURE-PROOF LUMINAIRES WITH DIFFUSERS



Replacement gear tray for PAC series 1/1500

Type	Colour temp. (K)	Luminous flux (Lm)	System power (W)	Article No.	Gross €/pcs.
Gear tray for PAC series 1/650	4000	2300 / 1500	17 / 10	3607 4030	49.00
Gear tray for PAC series 1/1200	4000	4600 / 2800	33 / 19	3607 4025	62.00
Gear tray for PAC series 1/1500	4000	5900 / 3700	43 / 25	3607 4000	68.50
Gear tray for PAC series 1/1500	4000	9000	60	3607 4005	128.50
Gear tray for PAC series 1/1500	6500	9000	60	3607 4010	130.50
Gear tray for PAC series 1/1500	4000	12,600	80	3607 4015	198.00
Gear tray for PAC series 2/1500	4000	18,000	110	3607 4020	258.00



The matching gear tray is specified in the data sheets for each luminaire. The data sheets list all relevant information about the luminaire, including the dimensions of the required gear tray.

Closures



Stainless-steel clip, 1-piece



PAC-D LED EL with stainless-steel clip



Plastic articulated clip, 3-piece



PAC-D LED EL with plastic clip



Stainless-steel clip, 1-piece



LZP with stainless-steel clip



Plastic clip, 1-piece

Compatible with all PAC-D LED types | PAC-D for LEDtube

Type	Article No.	Gross €/pcs.
1 Closure KIT, stainless steel (V2A) PAC-D	3596 0230	12.30
Art. No. 3597 4185 – E-1tlg v03 (stainless-steel clip), 10 pcs.		
2 Closure KIT, plastic PAC-D	3596 0980	12.30
Art. No. 3595 0127 – K-3tlg v01 (plastic articulated clip, 3-piece), 10 pcs. Art. No. 3500 0060 – Pan head screw 4x12 Torx, galvanised steel 17B2		

Compatible with all LZP types | LZP for LEDtube

Type	Article No.	Gross €/pcs.
3 Closure KIT, stainless steel (V2A) LZP	3596 0224	17.30
Art. No. 3596 2165 – E-1tlg v02 (stainless-steel clip), 10 pcs. Art. No. 3598 0153 – Reducer PG13.5, 2 pcs. Art. No. 3597 0291 – Mounting bracket LZP, 2 pcs. Art. No. 3597 0271 – Wire spring (clip), 2 pcs.		
4 Closure KIT, plastic LZP	3596 0226	17.30
Art. No. 3598 0388 – K-1tlg v03 (plastic clip), 10 pcs. Art. No. 3598 0153 – Reducer PG13.5, 2 pcs. Art. No. 3597 0291 – Mounting bracket LZP, 2 pcs. Art. No. 3597 0271 – Wire spring (clip), 2 pcs.		

Installation components / Wire mesh protection

Compatible with all PAC-D LED types | PAC-D for LEDtube | LZP | LZP for LEDtube

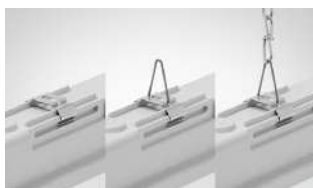

Mounting bracket and chain with hanger.



Suspended mounting from a chain or cable is possible with the included stainless-steel mounting brackets and hangers.

Type	Article No.	Gross €/pcs.
Mounting brackets PAC-D (1-lamp)	3597 0290	4.25
Mounting brackets PAC-D / LZP (2-lamp)	3597 0291	4.25
Wire spring (clip)	3597 0271	0.61
Chain, 1 bundle, 30 m	7414 9022 •	40.60

Two mounting brackets and clips are already included with the luminaire.

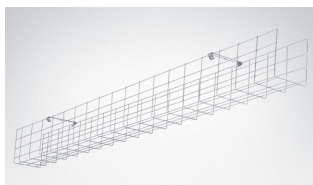

Wire mesh protection
Welded, galvanised steel



Wire mesh protection SG 1/36
(figure shows PAC-D EL)

Type	L	W	H	Article No.	Gross €/pcs.
SG 1/36 with two brackets each	1305	130	150	3607 8001	48.50
SG 1/58 with two brackets each	1605	130	150	3607 8002	54.80
SG 2/36 with two brackets each	1305	230	150	3607 8004	63.50
SG 2/58 with two brackets each	1605	230	150	3607 8005	73.80

• available ex stock

Replacement diffusers and luminaire housings for ALSF | AOT | Euro-Line

This overview is designed to help you choose separate diffusers and luminaire housings.

Diffuser ALSF | AOT (RWA0)

Opal acrylic diffuser (PMMA), angular design.



Type	Article No.	Gross €/pcs.	Compatible with	Page
Diffuser RWA0 118	4496 0040	16.00	ALSF ML 650	18
			AOT ML 650	30
Diffuser RWA0 136	4497 0040	20.60	ALSF ML 1260	18
			AOT ML 1250	30
Diffuser RWA0 158	4500 0040	21.50	ALSF ML 1560	18
			AOT ML 1550	30
Diffuser RWA0-Mini T5 14/24	4496 5000	26.90	AOT Mini ML 600	31
Diffuser RWA0-Mini T5 28/54	4497 5000	38.10	AOT Mini ML 1200	31
Diffuser RWA0-Mini T5 35/49	4500 5000	43.30	AOT Mini ML 1500	31

Euro-Line diffuser

Opal acrylic diffuser (PMMA), bevelled edges.



Type	Article No.	Gross €/pcs.	Compatible with	Page
Diffuser Euro-Line 118	4552 0000	15.00	Euro-Line Aqua ML 650	19
			Euro-Line ML 650	32
Diffuser Euro-Line 136	4553 0000	19.50	Euro-Line Aqua ML 1270	19
			Euro-Line ML 1250	32
Diffuser Euro-Line 158	4554 0000	21.50	Euro-Line Aqua ML 1570	19
			Euro-Line ML 1550	32
Diffuser Euro-Line Mini T5 14/24	4552 5000	26.90	Euro-Line Mini ML 600	33
Diffuser Euro-Line Mini T5 28/54	4553 5000	38.10	Euro-Line Mini ML 1200	33
Diffuser Euro-Line Mini T5 35/49/80	4554 5000	43.30	Euro-Line Mini ML 1500	33

Luminaire housing ALSF | Euro-Line Aqua

Type	Version	Colour temp. (K)	System power (W)	Article No.	Gross €/pcs.	Compatible with	Article No.	Page
Housing ALSF ML 650	Basic	3000	27 / 16	6488 1150	84.00	ALSF ML 650 Basic	6011 1110	18
						Euro-Line Aqua ML 650 Basic	6011 1130	19
	Basic	4000	27 / 16	6488 1160	84.00	ALSF ML 650 Basic	6011 1120	18
						Euro-Line Aqua ML 650 Basic	6011 1140	19
Housing ALSF ML 1250	Basic	3000	42 / 27	6488 1200	139.40	ALSF ML 1260 Basic	6011 1200	18
						Euro-Line Aqua ML 1270 Basic	6011 1290	19
	Basic	4000	42 / 27	6488 1210	139.40	ALSF ML 1260 Basic	6011 1210	18
						Euro-Line Aqua ML 1270 Basic	6011 1295	19

Luminaire housing ALSF | Euro-Line Aqua

Type	Version	Colour temp. (K)	System power (W)	Article No.	Gross €/pcs.	Compatible with	Article No.	Page
Housing ALSF ML 1250	HF sensor	3000	42 / 27	6488 1215	220.50	ALSF ML 1260 HF	6011 1220	18
						Euro-Line Aqua ML 1270 HF	6011 1300	19
	4000	42 / 27	6488 1230	220.50	ALSF ML 1260 HF	6011 1230	18	
						Euro-Line Aqua ML 1270 HF	6011 1310	19
Housing ALSF ML 1250	EL3h	3000	42 / 27	6488 1220	329.40	ALSF ML 1260 EL3h	6011 1240	18
		4000	42 / 27	6488 1235	329.40	ALSF ML 1260 EL3h	6011 1250	18
Housing ALSF 1250	DALI	3000	42	6488 1225	191.40	ALSF 1260 DALI	6011 1280	18
		4000	42	6488 1240	191.40	ALSF 1260 DALI	6011 1285	18
Housing ALSF ML 1550	Basic	3000	55 / 43	6488 1500	148.50	ALSF ML 1560 Basic	6011 1600	18
						Euro-Line Aqua ML 1570 Basic	6011 1680	19
	4000	55 / 43	6488 1510	148.50	ALSF ML 1560 Basic	6011 1610	18	
						Euro-Line Aqua ML 1570 Basic	6011 1685	19
Housing ALSF ML 1550	HF sensor	3000	55 / 43	6488 1511	263.50	ALSF ML 1560 HF	6011 1620	18
						Euro-Line Aqua ML 1570 HF	6011 1690	19
	4000	55 / 43	6488 1514	263.50	ALSF ML 1560 HF	6011 1630	18	
						Euro-Line Aqua ML 1570 HF	6011 1695	19
Housing ALSF ML 1550	EL3h	3000	55 / 43	6488 1512	347.50	ALSF ML 1560 EL3h	6011 1640	18
		4000	55 / 43	6488 1515	347.50	ALSF ML 1560 EL3h	6011 1650	18
Housing ALSF 1550	DALI	3000	55	6488 1513	192.50	ALSF 1560 DALI	6011 1660	18
		4000	55	6488 1516	192.50	ALSF 1560 DALI	6011 1670	18

Luminaire housing AOT | Euro-Line

Type	Version	Colour temp. (K)	System power (W)	Article No.	Gross €/pcs.	Compatible with	Article No.	Page
Housing AOT ML 650	Basic	3000	27 / 16	7010 3100	59.50	AOT ML 650 Basic	7010 3050	30
						Euro-Line ML 650 Basic	7010 3150	32
	4000	27 / 16	7010 3110	59.50	AOT 650 ML Basic	7010 3060	30	
						Euro-Line ML 650 Basic	7010 3160	32
Housing AOT ML 1250	Basic	3000	42 / 27	7014 3100	94.00	AOT ML 1250 Basic	7011 3050	30
						Euro-Line ML 1250 Basic	7011 3150	32
	4000	42 / 27	7014 3110	94.00	AOT ML 1250 Basic	7011 3060	30	
						Euro-Line ML 1250 Basic	7011 3160	32
Housing AOT ML 1550	Basic	3000	55 / 43	7014 3200	113.80	AOT ML 1550 Basic	7012 3050	30
						Euro-Line ML 1550 Basic	7012 3150	32
	4000	55 / 43	7014 3210	113.80	AOT ML 1550 Basic	7012 3060	30	
						Euro-Line ML 1550 Basic	7012 3160	32
Housing AOT Mini ML 600	Basic	3000	27 / 16	7005 2005	48.60	AOT Mini ML 600 Basic	7005 0015	31
						Euro-Line Mini ML 600 Basic	7005 0010	33
	4000	27 / 16	7005 2000	48.60	AOT Mini ML 600 Basic	7005 0055	31	
						Euro-Line Mini ML 600 Basic	7005 0050	33
Housing AOT Mini ML 1200	Basic	3000	42 / 27	7005 3005	76.50	AOT Mini ML 1200 Basic	7005 0105	31
						Euro-Line Mini ML 1200 Basic	7005 0100	33
	4000	42 / 27	7005 3000	76.50	AOT Mini ML 1200 Basic	7005 0155	31	
						Euro-Line Mini ML 1200 Basic	7005 0150	33
Housing AOT Mini ML 1500	Basic	3000	55 / 43	7005 4005	92.00	AOT Mini ML 1500 Basic	7005 0205	31
						Euro-Line Mini ML 1500 Basic	7005 0200	33
	4000	55 / 43	7005 4000	92.00	AOT Mini ML 1500 Basic	7005 0255	31	
						Euro-Line Mini 1500 ML Basic	7005 0250	33

Service and upgrades



The Fluolite service concept: A professional and proficient approach for the perfect lighting solution.

You can rely on our expertise. Fluolite will assist you at every step from the planning phase to the actual implementation. Simply get in touch with us, we look forward to receiving your enquiry.

The Fluolite service concept is divided into three phases:



Phase 1

Needs assessment

- ☞ Define goals
- ☞ Carry out an inventory
- ☞ Identify what is missing



Phase 2

Advice and planning

- ☞ Select the required products
- ☞ Create a lighting plan based on the chosen products
- ☞ Coordinate the lighting solution



Phase 3

Implementation

- ☞ Determine the project costs
- ☞ Prepare an amortisation calculation
- ☞ Project release
- ☞ If applicable, submit a funding application
- ☞ Project execution



High time for a sustainable refurbishment project: Sustainable refurbishment continues to gain in importance.

Fluolite makes a key contribution when it comes to sustainable lighting upgrades. We lay the foundation for this with our high-quality and durable “Made in Germany” luminaires.

Their high efficiency guarantees permanently low energy consumption, while a long lifetime of $\geq 50,000$ hours with L80 keeps the overall operating and maintenance costs at a low level.

We also offer interchangeable components for many of our luminaires. This increases longevity and conserves resources. We will be happy to advise you and find the perfect solution.

Advantages of our sustainable upgrade solutions:

Become more environmentally friendly

A lighting upgrade project is a simple and effective step towards greater environmental protection. The lower energy consumption of efficient luminaires not only reduces your costs, but also your CO₂ emissions. In this way, you can make an active contribution to protecting the environment while also benefitting from improved lighting.

Superior light quality

Upgraded lighting not only improves efficiency, but also the quality of the light. With modern LED luminaires, each room will be brighter and more evenly lit, creating a more pleasant and productive environment. LEDs also reduce maintenance costs and extend the replacement intervals thanks to their longer lifetime.

Lower maintenance costs

Upgraded lighting can make all the difference when it comes to cost savings through improved energy efficiency. Significant savings can be achieved by using more efficient luminaires that consume less electricity. Take the opportunity to lower your electricity bills in the long term and simultaneously improve the performance of your lighting.



Fluolite after-sales service: How may we assist you?

If you have any questions about spare parts or repairs, or need assistance due to incorrectly functioning products, please don't hesitate to contact us.

Our team is at your disposal. Rely on our expertise in creating successful solutions.

We look forward to assisting you and to ensuring that you are completely satisfied with our services and products.

We provide the best possible service as a matter of course.



Advice and assistance



Outstanding reliability



Support



Quality



Satisfaction



Subsidised Fluolite luminaire families:



Luminaires with a higher protection grade

PAC-D EL ML	13 – 14
PAC-D EL Q	15
PAC-D HP	16
LZP	17



Luminaires for special applications

PAC-D AI	22 – 23
LZP HT	24 – 25



Surface-mounted luminaires

AOT Mini ML	31
Euro-Line Mini ML	33
DeSpl	34
LUX ML LUX	36 – 37
LUX ASYM	39



Wall and ceiling luminaires

Weiler FL	44
Weiler-Z FL	45
RKL ML	50 – 52
RKL-Z ML	53 / 55
RKL-Aqua	56 – 57
Quadro-Lite	60



Lay-in and panel luminaires

Modul Four EL	64
Modul Four	65
FLAT-A	68



Trunking systems and trunking inserts

TRX Lens	79
Luminaires with "click & connect" connection	87

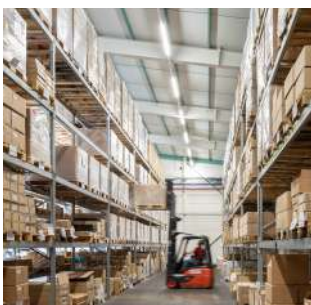

High-bay luminaires

PAC-D MaXX	92
PAC-D MaXX Focus	92



Ball-proof luminaires

InAct	96
Salem FL	97

Please check each individual product you wish to purchase to see if it is eligible.

Please visit the BAFA website (www.bafa.de) for information on the current federal subsidies for efficient buildings.



Chemical resistance

This table provides an overview of the chemical resistance of the key materials used in luminaire construction.

Subsequent problems and complaints can often be pre-empted by referring to this information. The type and composition of the chemical substances can cause the materials of the luminaires to deteriorate at different temperature ranges.

Example applications where material deterioration may occur:

- Food processing industry, kitchens, meat processing areas, cheese factories, dairies (also due to the cleaning agents used here).
- In areas where oils, greases and lubricants or chlorine vapours occur more frequently or direct contact with these substances is possible – diffusers made of PMMA in conjunction with V2A closures should be used.

The information on chemical resistance refers to an ambient temperature of approx. 22 °C.

Chemical substance	Glass-fibre-reinforced polyester (GRP)	Polymethyl methacrylate (PMMA)	Poly-carbonate (PC)	Noryl® closure	Stainless-steel closure
Acetone	x	x	x	x	●
Alcohol up to 30%	●	●	●	●	●
Alcohol, concentrated	○	x	x	●	●
Aliphatic hydrocarbons	○	○	●	○	●
Accumulator acid	●	●	●	—	●
Ammonia 25%	x	●	x	●	●
Aniline	x	x	x	x	●
Aromatic hydrocarbons	○	x	x	x	●
Ether	○	x	x	○	●
Ethyl acetate (ester)	x	x	x	●	●
Benzene	x	x	x	x	●
Benzine (cleaning solvent)	●	●	●	x	●
Beer	●	●	●	●	●
Blood	●	●	●	●	●
Bromic acid	x	x	x	x	—
Chloroform	x	x	x	x	—
Chlorophenol	x	x	x	x	—
Diesel fuel	●	●	○	○	●
Dioxane	x	x	x	x	●
Acetic acid up to 5%	●	○	●	—	—
Acetic acid up to 30%	x	x	●	—	—
Ethanol up to 30%	●	○	●	●	●
Ethanol above 30%	x	x	●	●	●
Mineral fat	●	●	x	x	●
Vegetable fat	●	●	x	x	●
Animal fat	●	●	x	x	●
Glycerine	●	●	○	x	●
Glycol	●	●	●	●	●
Glystantine	●	●	●	—	●
Heating oil	●	○	x	x	●
Potash lye 30%	x	●	x	○	●
Milk of lime	●	●	○	○	●
Carbon dioxide	●	●	●	●	●
Carbon monoxide	●	●	●	●	●
Saline solution	●	●	●	●	○
Ketones	x	x	x	x	●
Lysol	x	x	x	x	●
Seawater	●	●	●	●	○
Methanol	x	x	x	x	x
Lactic acid, aqueous 10%	●	●	●	●	●
Caustic soda 2%	x	●	x	●	●
Caustic soda 10%	x	●	x	●	●
Regular petrol	●	x	○	x	●
Petroleum ether	—	●	○	x	●
Pyrin	x	x	x	x	●
Phenol	x	x	x	x	●
Nitric acid up to 10%	x	●	●	●	x
Nitric acid up to 20%	x	○	○	●	x
Nitric acid above 20%	x	x	x	●	x
Hydrochloric acid up to 10%	x	●	●	●	x
Hydrochloric acid above 20%	x	●	○	●	x
Sulphuric acid up to 50%	●	●	●	●	x
Sulphuric acid up to 70%	x	○	○	●	x
Sulphuric acid above 70%	x	x	x	○	x
Sulphurous acid up to 5%	○	○	x	●	x
Hydrogen sulphide	●	●	●	—	—
Soap solution	●	●	●	●	●
Silicone oil	●	○	●	x	●
Soda	●	●	●	●	●
Premium petrol	●	x	x	x	●
Synthetic detergent solution	●	●	○	○	●
Turpentine oil	●	○	○	x	●
Carbon tetrachloride	x	x	x	x	●
Water up to 60°C	●	●	●	●	●
Hydrogen peroxide up to 40%	x	x	○	x	●
Hydrogen peroxide above 40%	x	x	○	x	●
Xylene	x	x	x	x	●



Please note that high-pressure cleaners must not be used.

When cleaning the diffusers/housings, we recommend using a weak solution of the appropriate agents.

The use of chemical cleaning agents is possible to a limited extent, however please consult us first.

- Resistant
- Limited resistance
- x Not resistant
- Not tested



The code for your light!

Scan it to learn more:
www.fluolite.de

Technical information – HF sensor

Connection diagram master/slave

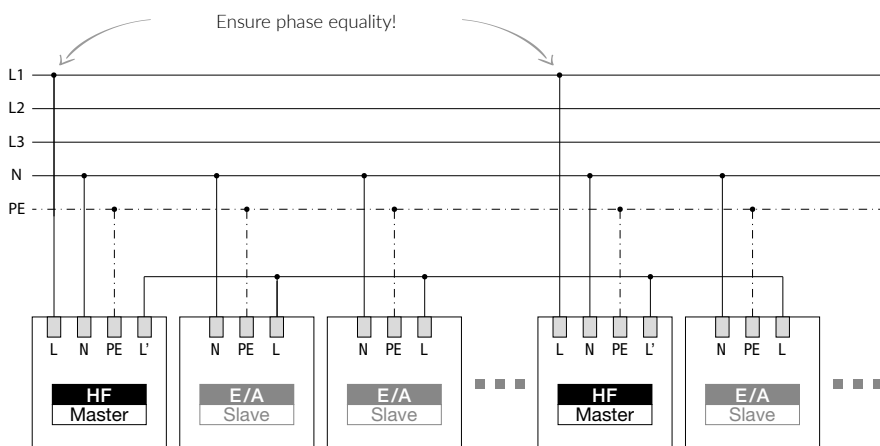

Instead of only switching slave devices on/off as in this example, other compatible switching types are possible, e.g. with DALI.



Maximum switching capacity = 400 VA (Watts)

Example 1:



RKL 2 LED with 12 watts each:
 1 x luminaire with HF sensor & max. 32 x RKL 2 LED On/Off
 2 x luminaire with HF sensor & max. 31 x RKL 2 LED On/Off

Example 2:



RKL 4 LED with 37 watts each:
 1 x luminaire with HF sensor & max. 9 x RKL 4 LED On/Off
 2 x luminaire with HF sensor & max. 8 x RKL 4 LED On/Off



Detection zone

1 – 9 metres, depending on installation type (wall or ceiling)

The detection zone can be narrowed down by selecting the combination with the DIP switches.



Time cycle

5 seconds – 30 minutes

When a movement is detected, the time cycle can be selected by configuring the DIP switches. This function is deactivated when there is sufficient daylight.



Twilight threshold

2 Lux – 50 Lux

To prevent unnecessary activation of the lights when there is sufficient daylight, the threshold value for the residual light detection can be set.



Precautions for product installation and commissioning for luminaires with HF motion sensors are available at:
www.fluolite.de/download

IP protection grades

Luminaires and other electrical equipment must not pose a hazard under any circumstances. Therefore, they must undergo certain tests depending on the requirements and intended use. In this way, safe operation is guaranteed over the entire lifetime of the product. By means of the IP protection grade and protection class, the requirements are defined in detail on the basis of various standards.

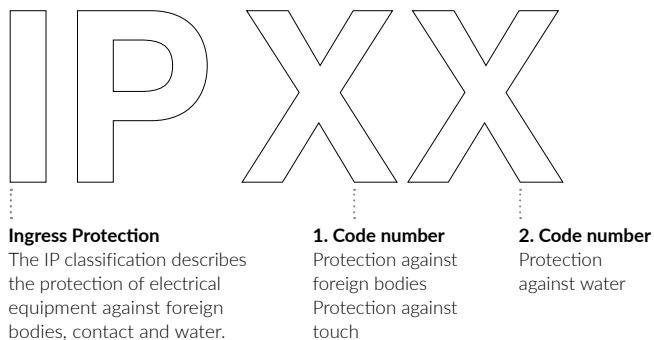

What is the protection grade?

The protection grade defines the suitability of electrical equipment for certain environmental conditions. Depending on the classification, the unit must be protected to a greater or lesser degree against the ingress of moisture and other foreign bodies. The impact resistance is also determined by the protection grade.

What does the IP protection grade mean?

The abbreviation **IP** stands for **International Protection**. It is also commonly referred to as “ingress protection”, which means protection against penetration by external elements. Next to the IP abbreviation there are **two code numbers** which define the exact classification of the protection grade. These code numbers are defined in the German standard **DIN EN 60529** and the international standard **ISO 20653**. Compliance with the protection grade is the responsibility of both the installer during installation and the operator during the service life of the lighting installation.

First code number	Protection against foreign bodies and touch	Second code number	Protection against water (liquids)
IP 0X	No protection against foreign bodies, no protection against touch.	IP X0	No protection against water.
IP 1X	Protection against foreign bodies with $\varnothing \geq 50$ mm; protection against extensive contact with the hand.	IP X1	Protection against vertically falling drops of water.
IP 2X	Protection against foreign bodies with $\varnothing \geq 12$ mm; protection against touching with the finger.	IP X2	Protection against drops of water falling diagonally at up to 15°.
IP 3X	Protection against foreign bodies with $\varnothing \geq 2.5$ mm; protection against contact with tools or wire.	IP X3	Protection against drops of water falling diagonally at up to 60°.
IP 4X	Protection against foreign bodies with $\varnothing \geq 1.0$ mm; protection against contact with tools or wire.	IP X4	Protection against splashing water from all directions.
IP 5X	Protection against internal dust deposits; complete protection against touch	IP X5	Protection against jets of water from any direction.
IP 6X	Dust-proof; complete protection against touch.	IP X6	Protection against strong jets of water.

Protection classes

The protection class indicates which protective measures are necessary against direct or indirect contact. A distinction is made between protection classes I and II.

⊕ Protection class 1 (I)

In **protection class I**, the protection goal is achieved by insulating live parts (so-called “basic insulation”) and by connecting conductive exposed metal parts to the **earth conductor**.

□ Protection class 2 (II).

In equipment that complies with **protection class II**, live parts are covered with **protective insulation** in addition to the basic insulation. An earth-conductor connection is not necessary. System-specific protective measures are not necessary.

Certification marks

⚠ Only luminaires with a limited surface temperature may be used in operating sites where a fire hazard exists. In premises where a fire hazard exists due to dust and/or fibres, the luminaires must also be designed to prevent the dust and fibres from accumulating on them in dangerous quantities. In such areas, luminaires with the ⚠ symbol are guaranteed to meet the requirements for a limited surface temperature. Luminaires marked with the ⚠ symbol are suitable for rooms with an elevated fire risk. To limit their surface temperature, they are equipped with suitable lamps and gear.

CE The CE-marking is the responsibility of the manufacturer. In doing so, the latter confirms that the product conforms to the respective EC or EU Directives. Conformity with the Low Voltage Directive and the EMC Directive (immunity to interference, emitted interference) is a prerequisite for the CE-marking of our luminaires.

IK impact resistance grade

The IK impact resistance grade indicates the extent to which the housing is designed to resist strong mechanical impacts and shock stress. The European standard IEC 62262 lists

10 protection grades for impact resistance. It specifies the minimum impact energy in joules (J) that the housing must be able to withstand in order to ensure continued safe operation.

IK number	Impact resistance (joules)	Protection against	Distance	Luminaires	Page
IK 00	No protection	Not tested		-	
IK 01	Resistance to shocks with an impact energy of up to 0.15 joules	Blow from hammer weighing 200 g	7.5 cm	-	
IK 02	Resistance to shocks with an impact energy of up to 0.20 joules	Blow from hammer weighing 200 g	10 cm	ALSF ML, Euro-Line Aqua ML, AOT ML, AOT Mini ML, Euro-Line ML, Euro-Line Mini ML, DeSpl LUX ML, LUX, LUX ASYM Weiler FL, Weiler-Z FL, RKL ML, RKL-Z ML, RKL-Aqua Quadro-Lite Modul Four EL PAC-D MaXX Focus PAC for LEDtube ALSF for LEDtube, Euro-Line Aqua for LEDtube, AOT for LEDtube, Euro-Line for LEDtube	18 – 19 30 – 34 36 – 39 44 – 57 60 64 92 99 101 – 102
IK 03	Resistance to shocks with an impact energy of up to 0.35 joules	Blow from hammer weighing 200 g	17.5 cm	PAC-D EL ML, PAC-D EL, PAC-D EL Q, PAC-D HP PAC-D AI Rondo-Lite 1x12 Modul Four TRX Lens PAC-D for LEDtube	13 – 16 22 – 23 61 65 79 99
IK 04	Resistance to shocks with an impact energy of up to 0.5 joules	Blow from hammer weighing 200 g	25 cm	-	
IK 05	Resistance to shocks with an impact energy of up to 0.7 joules	Blow from hammer weighing 200 g	35 cm	-	
IK 06	Resistance to shocks with an impact energy of up to 1 joules	Blow from hammer weighing 500 g	20 cm	RKL/PC RKL-Z/PC RKL-Aqua/PC Rondo-Lite 2x4.5 Flat-A ML, Flat-A, Flat-E ARO	50 – 52 53 – 54 56 – 57 61 67 – 69 72
IK 07	Resistance to shocks with an impact energy of up to 2 joules	Blow from hammer weighing 500 g	40 cm	PAC-D/PC EL ML LZP LZP HT Bodmann FL LZP for LEDtube Euro-FFL for LEDtube	13 17 24 – 25 73 100 100
IK 08	Resistance to shocks with an impact energy of up to 5 joules	Blow from hammer weighing 1.7 kg	29.5 cm	HiLu ML Salem FL	93 97
IK 09	Resistance to shocks with an impact energy of up to 10 joules	Blow from hammer weighing 5 kg	20 cm	-	
IK 10	Resistance to shocks with an impact energy of up to 20 joules	Blow from hammer weighing 5 kg	40 cm	InAct	96

Sustainable products from Fluolite



Help us play our part in protecting the environment.
With the NEW FLUOLITE, you have the right partner at your side.





Our actions are increasingly determined by the need to make ever more efficient use of existing resources. We proactively address the resulting continuous ecological, legal and societal changes.

In the European Union, a package of measures was adopted in the form of the Ecodesign Directive, which, among other things, contains mandatory specifications for the energy efficiency of luminaire components and serves as a reference point with regard to conserving resources and reducing CO₂ emissions.

For our company, this provides the foundation for a product portfolio that is in step with the market and the times, both today and in the future. We have been producing “Made in Germany” luminaires since the 1950s.

Our premium, long-lasting FLUOLITE luminaires are based on our strict quality standards for materials, workmanship, technology and service. Efficient delivery channels, optimised and resource-saving production processes and interchangeable lighting technology are all cornerstones of our strategy.

- ✔ **German and European production in compliance with ISO 9001 and ISO 14001**
- ✔ **Efficient delivery and procurement channels**
- ✔ **In-house recycling: waste materials are returned to the production cycle**
- ✔ **Use of green electricity**
- ✔ **Sustainability through replaceable LED modules and components**
- ✔ **High luminous efficacy, with optimum efficiency**

Learn more on our website at:
www.fluolite.de/unternehmen/nachhaltigkeit



Notes

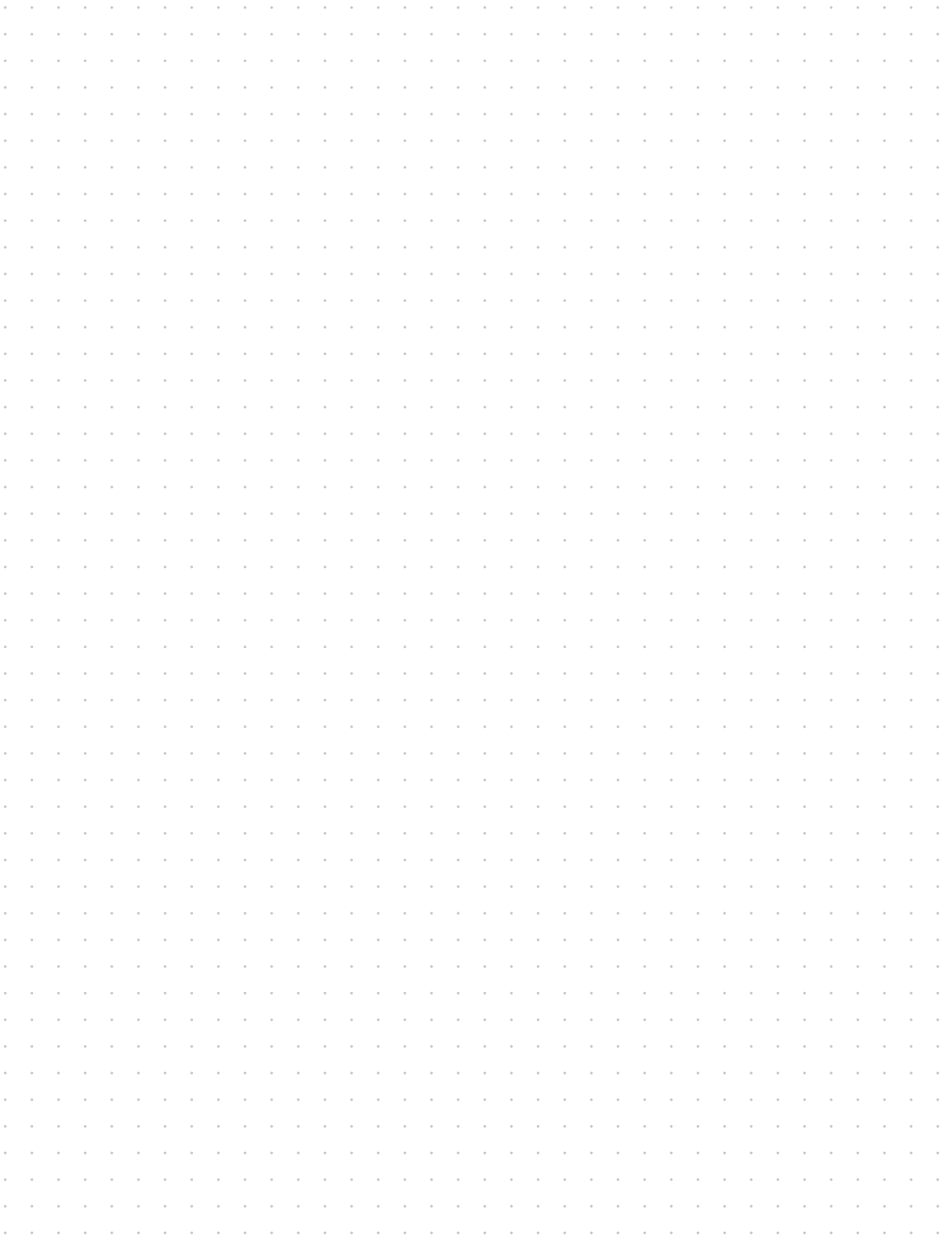

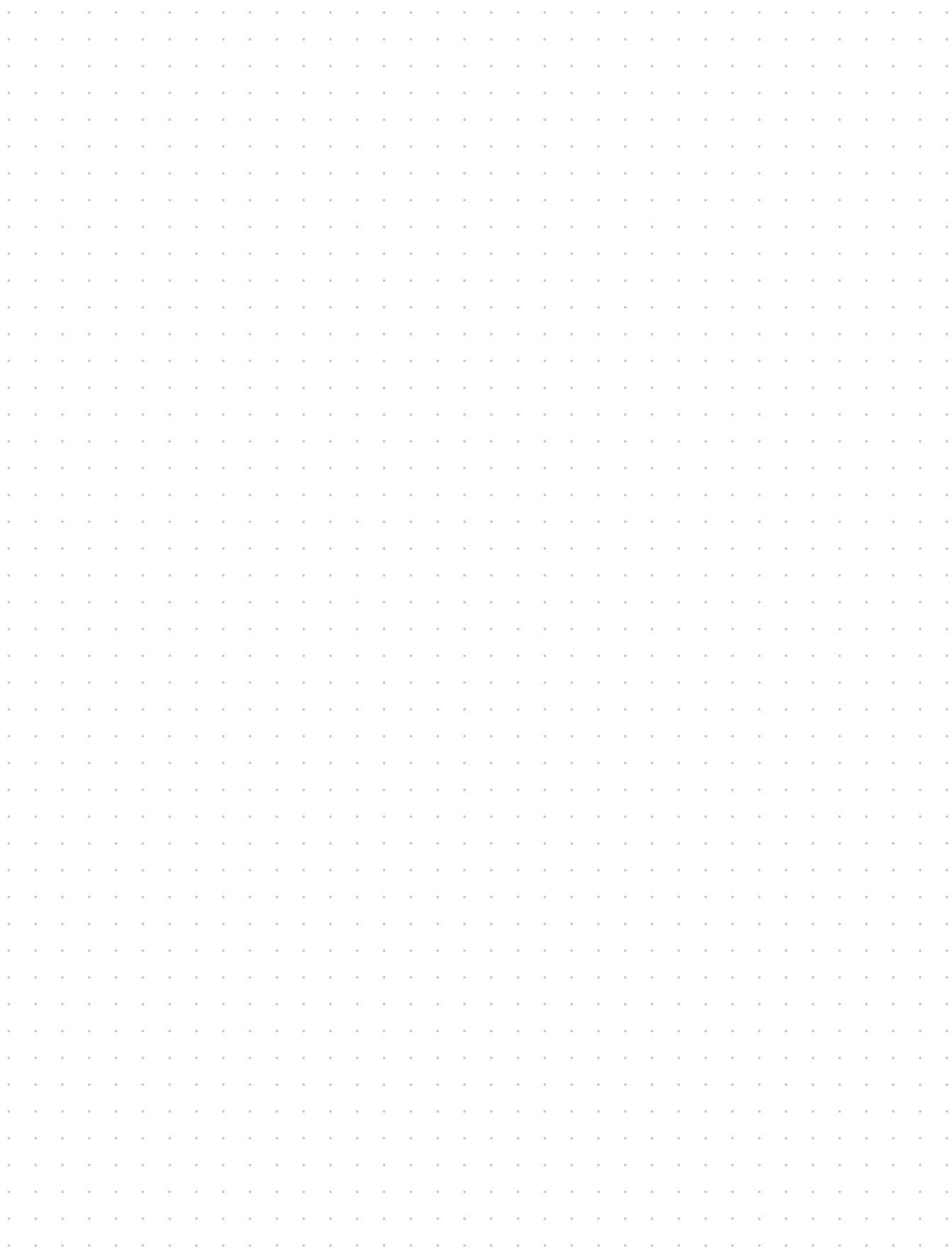

LED luminaire warranty

THE FLUOLITE QUALITY PLEDGE



Quality lighting – reflected by our warranty

Premium materials, precise workmanship and reliable partners – these are what make our products so dependable. Furthermore, we consistently adhere to the highest standards – we manufacture and test our products in accordance with the European standard DIN EN 60598 (VDE).

Our free luminaire warranty is based on our total confidence in our luminaire systems and gear. When you purchase a Fluolite product, we guarantee its quality and flawless performance under the terms of the warranty for a period of three or five years, based on the number of operating hours.



Five-year luminaire warranty

Our luminaires with a rated life expectancy of $\geq 50,000$ operating hours come with a five-year warranty.

Three-year luminaire warranty

We provide a warranty of up to three years for luminaires with a rated life expectancy of $< 50,000$ operating hours.



The warranty period starts from the date of invoice. Warranty claims must be submitted immediately after the occurrence of the defect along with our invoice as proof of purchase. The warranty is valid throughout Europe for all LED modules, LED gear and other LED components of our luminaires.

Our warranty is subject to the following terms and conditions:

Our warranty only covers failures due to material, design and manufacturing defects, as well as failures that exceed the rated failure rate of 0.2 % per 1,000 operating hours.

The average rate of decrease in luminous flux of LED modules occurs due to technical reasons up to a value of 0.6 % per 1,000 operating hours, and is therefore not covered by the warranty. As a result of technical advancements, deviations in light characteristics may occur when LED modules are replaced.

Moreover, the validity of any warranty claims is dependent on the fact that

- our luminaires are used as intended and the technical limit values are complied with;
- no modifications are made to our luminaires;
- their installation and maintenance is carried out by qualified personnel in accordance with the installation and maintenance instructions.

Our warranty includes the following services:

Our warranty extends to repair, replacement or crediting of the purchase price at our discretion. In the event of a replacement delivery, we shall be authorised to deliver a replacement product that deviates from the original due to technical advancements.

Any costs associated with the installation and removal of the defective product or the replacement product, as well as the costs of scaffolding and lifting platforms, transport, shipping and disposal are not covered under our warranty. We are also not liable for any other damage resulting from the failure of the luminaires.

The performance of a warranty service does not result in an extension of the warranty period.

The customer's statutory warranty rights shall remain unaffected. In all other respects, our general terms and conditions of sale shall apply.

Valid for orders from 2025-01-01.

Prices are valid until further notice or until 2027-01-31
for delivery by 2027-02-28.

This document replaces all previous price lists, which are no longer valid.

The listed gross prices are a non-binding price recommendation in EUR net/after deductions without VAT, and are based on the status at the time of printing. We reserve the right to implement price changes at short notice and the right to prior sale. This document is subject to errors and amendments. All stated dimensions (mm) are approximate.

In all other respects, our General Terms and Conditions of Sale and Delivery apply. You can find these on pages 130/131 and on our website at www.fluolite.de/agb.

Technical notes:

Special technical features, such as DALI versions, emergency lighting, HF sensors, etc. are available on request for almost every luminaire type.

We can also manufacture special luminaires based on your requirements or specifications.

Technical data as well as EPREL information can be found on the data sheets for each luminaire and on our website at www.fluolite.de.

Our luminaires comply with European technical standards and are CE-certified.

LED technology is subject to continuous advancements. The stated efficiency values reflect the state of the art at the time of printing. Continuously updated values are available on our website.

General Terms and Conditions of Sales

of Fluolite Licht & Leuchten GmbH & Co. KG (hereinafter referred to as „supplier“)

I. Scope

1. Our terms and conditions of sale apply exclusively. We do not accept contradictory conditions or conditions that differ from ours, unless we had expressly agreed to their scope in writing. Our terms and conditions of sale also apply if we deliver without reservations in the knowledge of contradictory terms and conditions or conditions that differ from ours.
2. All agreements made between us and the customer for the purpose of executing a contract must be laid down in writing in this contract.
3. Our terms and conditions of purchase only apply towards companies in accordance with § 310 para. 1 BGB (Civil Code).
4. Our terms and conditions of sales also apply to all future transactions.

II. Proposal – Proposal documents

1. If an order qualifies as a proposal in accordance to § 145 BGB (Civil Code), we are entitled to accept it within 2 weeks of receipt.
2. We reserve the right to ownership rights and copyright on figures, drawings, calculations and other documents. Third parties cannot have access to these without our express written consent.

III. Prices – Payment conditions

1. If there is no written agreement that differs, the prices quoted in the order are ex works, in Euro and do not include packaging.
2. The price indicated in the order is a net price. VAT is indicated separately per order for the entire order in the invoice.
3. The deduction of discounts requires a separate written agreement.
4. Unless otherwise agreed on in writing, deliveries are payable within 30 days, calculated from the time of delivery and receipt of invoice.
5. The customer is only entitled to set-offs if his counterclaims are legally effective, uncontested or recognized by us. In addition, he is only entitled to exercise retention rights if his counterclaim arises from the same contractual relationship.

IV. Delivery time

1. The start of the delivery time requires that all technical matters have been settled.
2. The fulfillment of our delivery obligation does also require that the customer has fulfilled all his obligations in time. We reserve the right to assert non-fulfillment of the contract.
3. If the customer is in default of acceptance or is otherwise in breach of his obligation to contribute, we are entitled to claim damages for any loss that might thus have been incurred.
4. In case of IV.3, the risk of accidental loss or accidental deterioration of goods is transferred to the customer at such time as he is in default of acceptance or payment.
5. We are liable in accordance with legal regulations if the underlying contract of sale is a firm deal according to § 286 para. 2 No 4 BGB (Civil Code) or § 376 HGB (Commercial Code). We are also liable in accordance with legal regulations if due to a default in delivery that we are responsible for the customer is entitled to assert that his interest in any fulfillment of the contract has been discontinued.
6. We are also liable in accordance with legal regulations if the default in delivery has been caused by a breach of contract that we are willfully or grossly negligently responsible for. If the default in delivery does not arise from a breach of contract that we are willfully responsible for, our liability is limited to a typical damage of the sort in question.
7. We are also liable in accordance with legal regulations if the default in delivery we are responsible for arises from our culpable breach of an integral provision of the contract, in which case our liability shall, however, be limited to a typical damage of the sort in question.
8. Otherwise, we are liable for default of delivery for any full week of such default to the amount of a flat rate of 0,5 percent of the delivery with a maximum total of 5 percent. Any further default in delivery liability is hereby excluded.
9. This is without prejudice to the customer's assertion of other legal rights.

V. Transfer of risk – Packaging costs

1. Unless otherwise stated in the order confirmation, delivery is ex works.
2. To taking back packaging, separate agreements shall apply.
3. On customer's request we shall arrange for insurance cover for the shipment; the customer shall bear the corresponding costs.

VI. Liability for defects

1. The customer's warranty claims require that he has fulfilled his inspection and complaint obligations in accordance to § 377 HGB (Commercial Code). Furthermore, the customer is obliged to inspect the object of sale at the location of the intended use.
2. If the object of sale shows a defect that occurred after the transfer of risk and which is not caused by faulty installation, we are with regard to supplementary performance at our discretion entitled to a replacement delivery or to issue a credit note in the amount of the purchase price. In case of replacement, product changes due to technical progress remain reserved.
3. If the supplementary performance should fail, the customer can choose either withdrawal or reduction at his discretion.
4. The compensation of costs arising from disassembly or installation is excluded, if the costs were neither necessary nor proportionate. The customer is required to provide the evidence for this purpose. Before conducting any work the customer is obliged to provide a cost estimate and to come to terms with us with.
5. We are liable in accordance with legal regulations, if the customer claims for damages arising from intention or gross negligence by our representatives or one of our vicarious agents. If the customer does not assert any willful breach of contract on our part, our liability is limited to a typical damage of the sort in question.
6. We are liable in accordance with legal regulations if we are responsible for a culpable breach of an integral provision of the contract, in which case our liability shall, however, be limited to a typical damage of the sort in question. Integral provisions of the contract are provisions, which shape the contract and the observance of which the contracting party regularly thrusts.
7. This is without prejudice to our liability for a culpable injury to life, limb or health. This does also apply to the compulsory liability arising from the product liability act.
8. Unless otherwise agreed in the above, any liability is excluded.
9. The statute of limitations for complaints expires after 12 months from transfer of risk.
10. This is without prejudice to the statute of limitations for delivery recourse pursuant to §§ 478, 479 BGB (Civil Code). This is five years from delivery of the defective object.

VII. Joint liability

1. Any further liability for damages other than set forth in item VI. – without consideration of the legal nature of the asserted claim – is hereby excluded. This does apply to claims for damages from culpability at the conclusion of the contract, other breaches of duty or for tort actions for property damages pursuant to § 823 BGB (Civil Code).
2. This limitation as stated above does also apply in case of a claim for damages the customer demands the reimbursement of useless expenditures. 3. In so far as our liability for damages is excluded or limited, this shall also apply to the personal liability for damages of our staff, representatives and vicarious agents.

VIII. Reservation of ownership

1. We reserve the ownership of the object of sale until all payments arising from the supply contract have come in. If the customer is in breach of contract, especially if he is in default of payment, we are entitled to take back the object of sale, which shall constitute withdrawal from the contract. After having taken back the object of sale, we are entitled to utilize it as we see fit. Such proceeds have to be set off against the customer's payables – minus appropriate utilization costs.
2. The customer is bound to treat the object of sale with diligent care. In particular is he contractually bound to insure it sufficiently against fire, water damages and theft at its replacement value at his own expense. If maintenance and inspection work has to be done, the customer has to do such in time and at his own expense.

3. In the event of distraint orders or other interventions by third parties, the customer has to notify us in writing forthwith, so that we are able to bring suit in accordance with § 771 ZPO (code of civil procedure). If third parties are unable to reimburse us the court and extrajudicial costs pursuant to § 771 ZPO (code of civil procedure), the customer is liable for the loss we have incurred.
4. The customer is entitled to sell the object of sale in the proper course of business. However, he hereby assigns all his receivables to our finally invoiced amount (including VAT), regardless of the object of sale having been sold prior to or after processing. The customer may still collect such receivables. This is without prejudice to our right to collect such receivables ourselves. However, we are hereby contractually bound not to collect such receivables if the customer is not in default of payment of the received proceeds, is not in default of payment in general and no petition in insolvency or composition has been filed or payments have not been suspended. If this is the case, however, we are entitled to demand that the customer notifies us of the assigned receivables and their debtors, gives us all data necessary for a collection of such receivables, hands over the attendant documents and notifies the debtors (third parties) of such assignment.
5. The processing or transformation of the object of sale shall always be done for us. If the object of sale is processed with other objects that do not belong to us, we are co-owners of the new object at the ratio of the object of sale's value at the time of processing (final invoiced amount, including VAT) to the other processed objects. The same provisions that apply to the object of sale delivered under reservation shall also apply to the new object.
6. If the object of sale is inseparably mixed with other objects that do not belong to us, we are co-owners of the new object at the ratio of the object of sale's value at the

time of mixing (final invoiced amount, including VAT) to the other mixed objects. If the mixing is done in a way that makes the customer's object the main part of the new object, it is hereby agreed that the customer makes us co-owner on a pro-rata basis. The customer is in possession of the thus evolved sole or co-ownership on our behalf.

7. The customer shall also assign to us his receivables from third parties that might arise when the object of sale is combined with a piece of real estate to cover his payables to us.
8. We are bound to release the securities we are entitled to in so far as that the realizable value of our securities exceeds the value of the secured receivables by more than 10 percent. The selection of the securities to be released is at our discretion.

IX. Place of jurisdiction – Place of fulfillment

1. If the customer is a „Kaufmann“ (i.e. business man) according to German commercial law, the place of jurisdiction is Tettngang. We are entitled to bring suit against the customer at his own place of jurisdiction.
2. These conditions of sale are subject to German law. Any applicability of the CSIG is hereby excluded.
3. Unless the order confirmation says otherwise, the place of fulfillment is Tettngang.

Version: January 2021

FLUOLITE

COMPETENCE IN
LIGHT & LUMINAIRES

Prinz-Eugen-Strasse 21
88069 Tett nang
GERMANY

+49 7542 517 0

info@fluolite.de

WWW.FLUOLITE.DE



QUALITY FROM SOUTHERN
GERMANY



QUALITY FROM
TETT NANG